

wilson
&bradley

TECHNICAL
SPECIFICATIONS

CINETTO

SLIDING SYSTEMS



MADE IN ITALY

CONTENTS



4. Overview

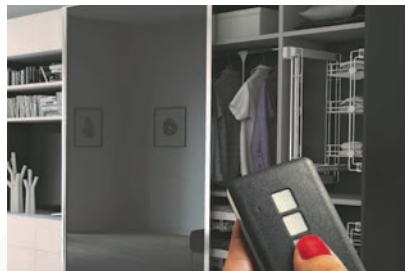

6. B-moved®



10. BASE (PS03)



14. VELOCE (PS06)



18. INVISIBLE (PS08)



22. LIBRO MAXI (PS11)



26. IDEA (PS22)



30. LIBRO (PS23)

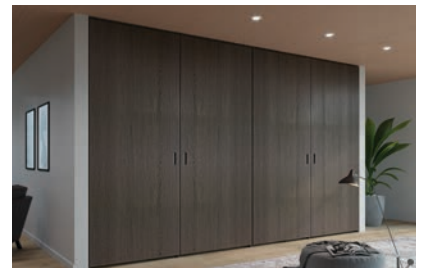

34. PIANO (PS40)



40. VOLO (PS48)



46. AGILE (PS60)



50. MAGICO (PS66)



54. Adjustable Door Straightener (BR04)

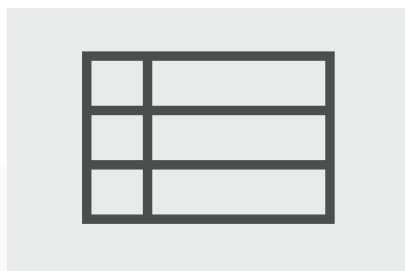

56. Range Selection Guide

CREATING
QUALITY
DESIGNS
SINCE
1948





CINETTO



Founded in Italy in 1948, Cinetto has grown from a small hardware shop to become one of the world's leaders in the production of sliding systems and designer aluminium profiles.

Using the most advanced production techniques, their history of manufacturing quality products allows them to develop products that not only look great but function effortlessly too.

The Cinetto range also includes industry leading technology in B-moved for electrical opening and closing of doors. B-moved ensures silent and safe movement of doors and is equipped with wave sensor and remote control capabilities.

wilson
&bradley
Exclusive



B-moved[®]



Introducing B-moved , market leading technology
that transforms the way you experience spaces.

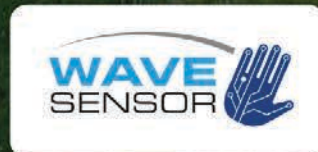



SMART TECHNOLOGY

B-moved[®] SMART TECHNOLOGY

Exclusive to Wilson & Bradley, B-moved[®] is industry leading technology, that allows for the electronic opening and closing of doors on many different systems.

B-moved[®] ensures silent and safe movement of doors, and is equipped with wave sensor and remote control capabilities. It is also smart home compatible, allowing you to control your doors at the click of a button. It brings forth a new experience of sliding, and adds a creative edge to new projects or renovations.

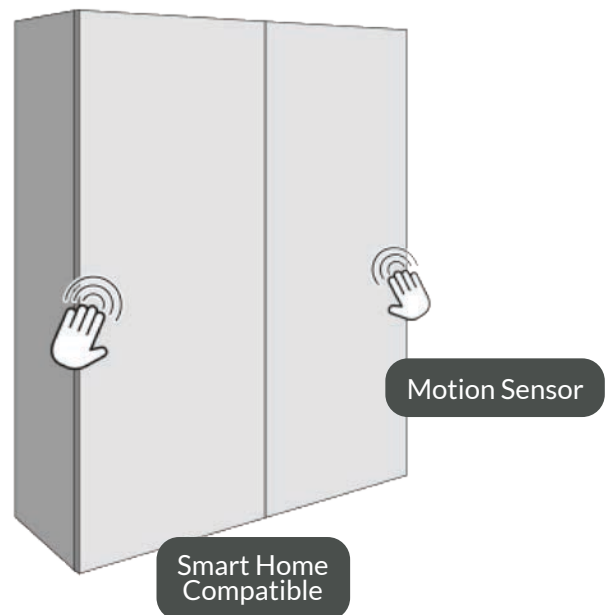

B-moved SMART TECHNOLOGY

Overview

- Compatible with PIANO (PS40) and VOLO (PS48)
- Exclusive to Wilson & Bradley
- Electric system for opening and closing of wardrobe doors
- Activates with remote control or wave sensor
- Can connect to smart lights or other electronic devices
- Can connect with a proximity sensor and with “Home Assistant” systems

Applications

- Wardrobes
- Storage cabinets
- Commercial applications
- Living room/TV cabinets

B-moved®

wilson
&bradley
Exclusive

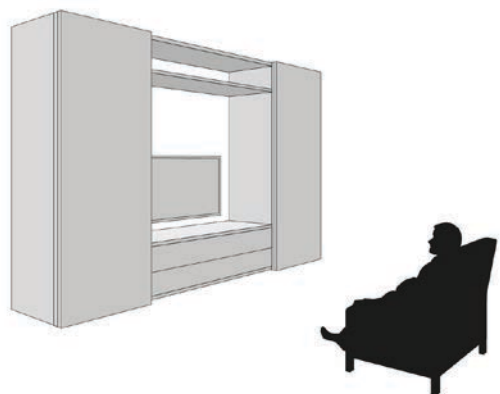
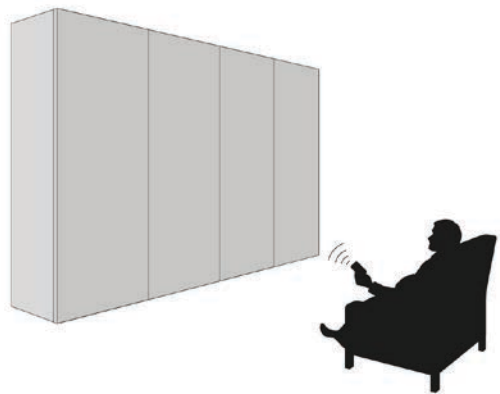
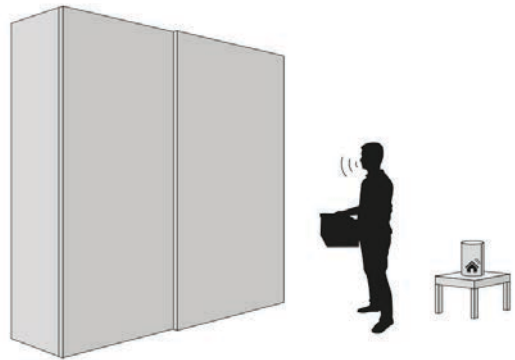



Opening Capabilities

Standard opening with manual input or by using the remote control.



Wave Sensor Technology

Wireless proximity sensor: Possibility of opening using wireless proximity sensors.

- New door control system via wireless proximity sensors
- Up to 10 sensors per door
- Max recommended distance between receiver unit and sensors: 10 meters
- 1 wave sensor unit every 2 doors



Smart Home Device Compatible

Compatible with Home Assistant systems, as well as smart phones.

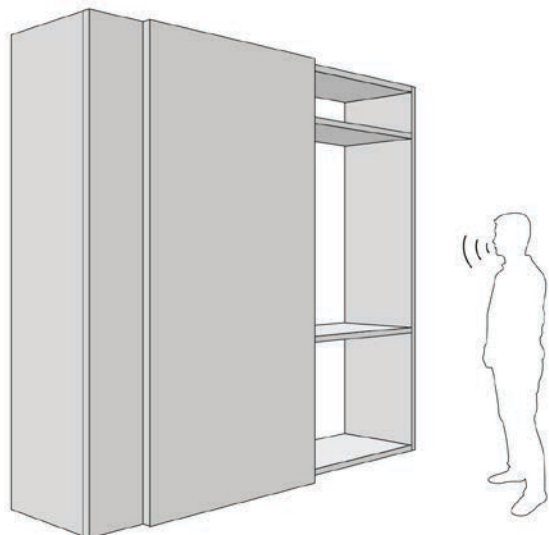

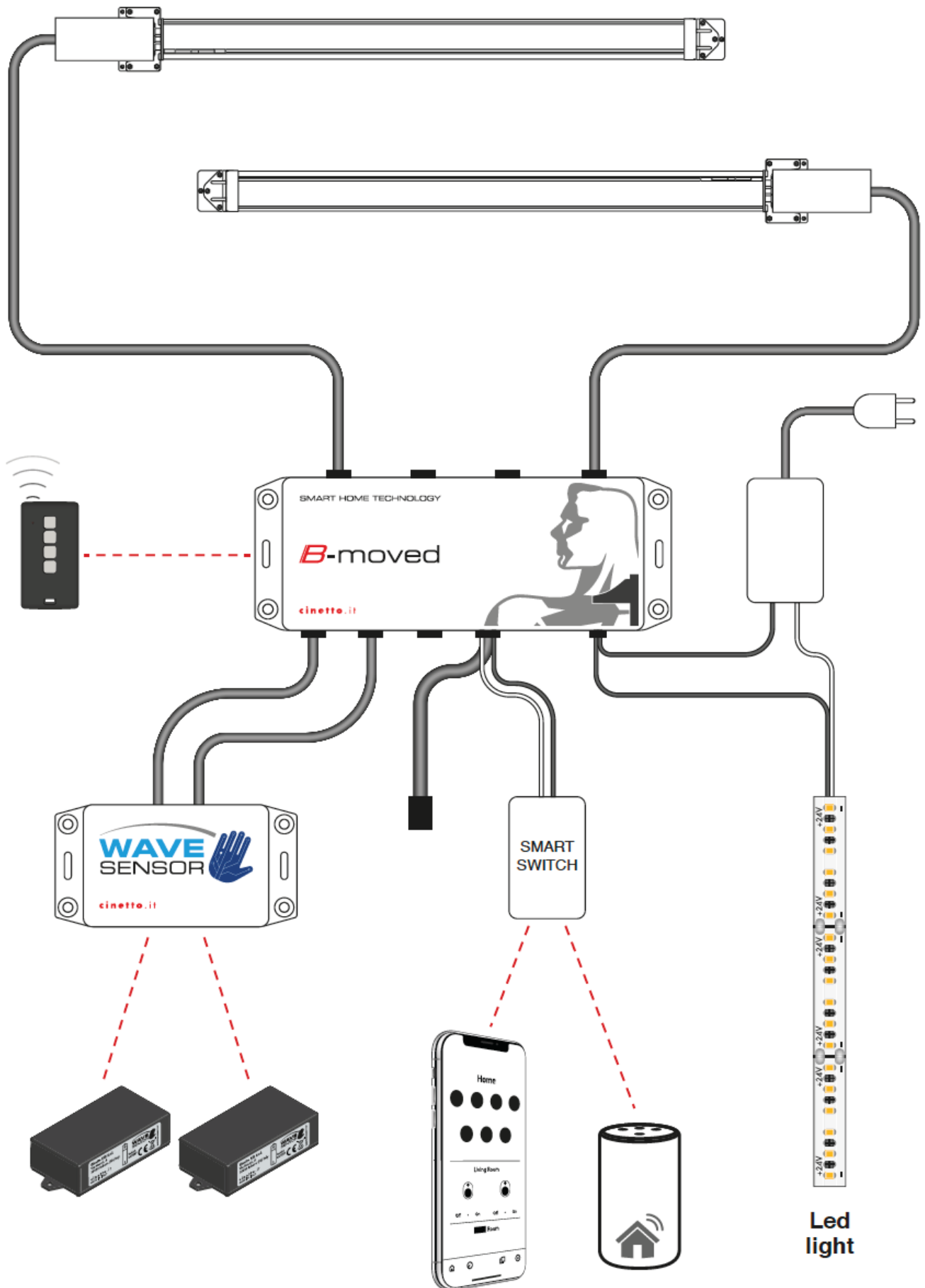



BASE (PS03) SLIDING SYSTEM FOR INTERNAL DOORS

MADE IN ITALY

The Cinetto BASE is a cost effective, simple to assemble, practical sliding system that can be used on a variety of applications such as a wardrobe, storage cabinets or overhead cabinets. The BASE uses a universal rebated top and bottom track with optional soft close features. This system is used for applications where the door sits inside the carcass.

Overview

- Cost effective system
- Easy to install
- Up to 20kg wooden doors
- Available with soft close
- ± 1.5 mm height adjustment

Applications:

- Kitchens
- Wardrobes
- Storage Units

Specifications

Track length: 3050mm

- Door thickness:
 - Wooden doors
 - With soft close: 16mm-20mm
 - Without soft close: 16mm-50mm
 - Glass doors
 - Without soft close: 5mm
- Max height: 1200mm
- Max width
 - With soft close: 500mm-1200mm
 - Without soft close: 400mm-1200mm
- Weight capacity: 20kg per door
 ± 1.5 mm height adjustment
- Applications (Wood and Glass)

HOW TO ORDER

STEP 1

Select Number of Doors

- Door kit
- Soft close (only for Wooden Doors)

STEP 2

Select the Door Material

- Wooden doors
- Glass doors

STEP 3

Select Rails:

- Upper/Lower rail

STEP 4

Optional:

- Catch for non soft-close



ORDER A CINETTO KIT:

Alternatively, you may choose to simply purchase a complete Cinetto kit.

See our website for full list of kits and further technical information: www.wilbrad.com.au

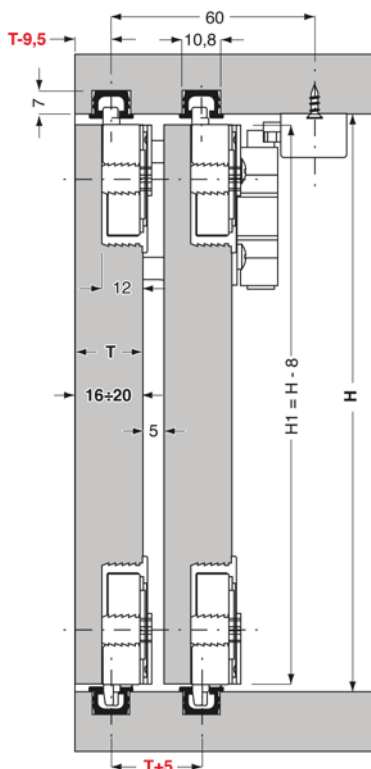

WOOD APPLICATION

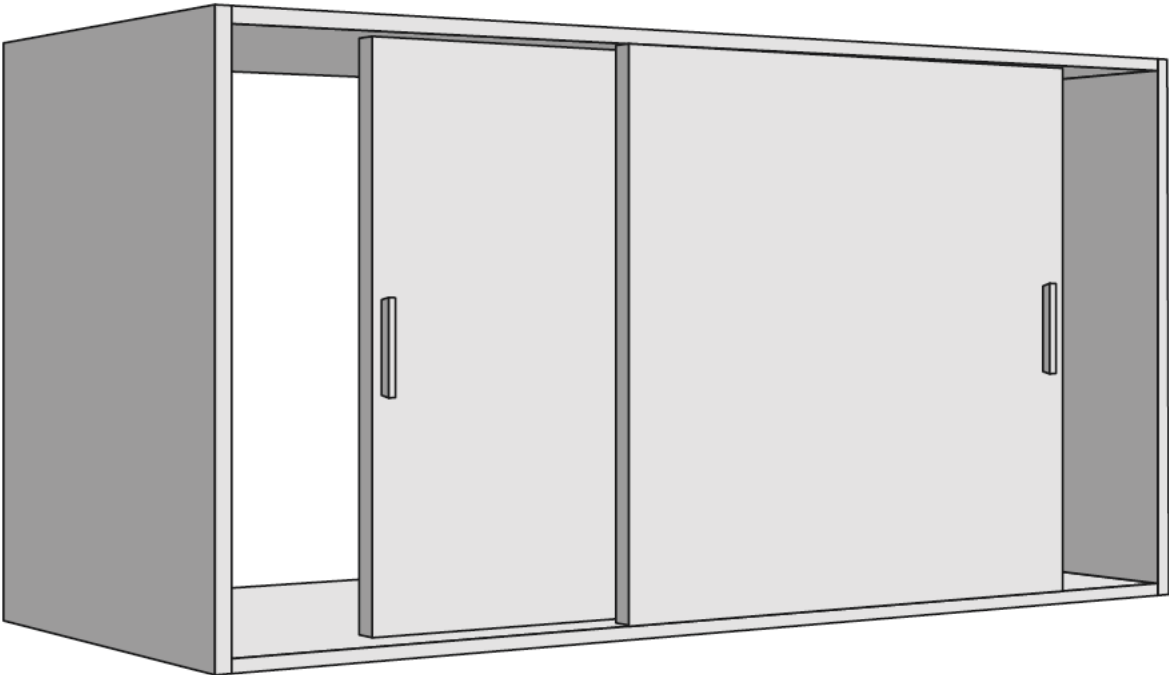

GLASS APPLICATION

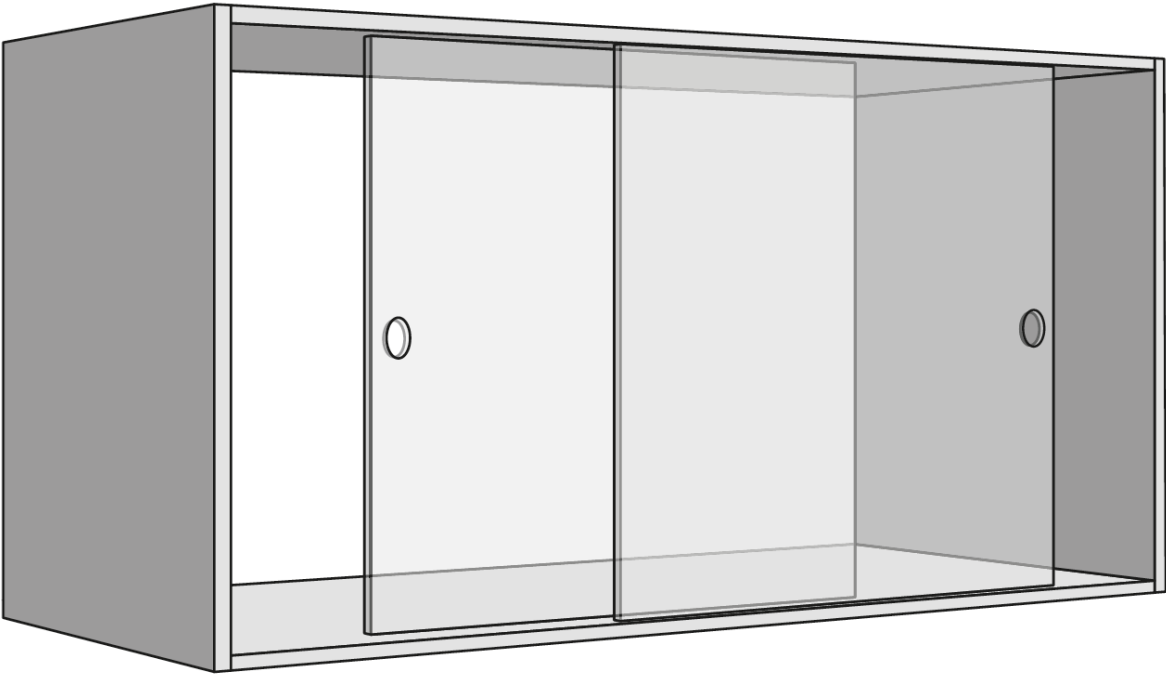

BASE COMPONENTS



KITS

DOOR KITS

CODE	DESCRIPTION	SOLD PER	LENGTH
CPS03DK	Cinetto BASE Sliding System for Internal Doors Sliding Kit Set for Wooden Doors. Includes 2x Upper Slides & 2 x Lower Slides	Set	-
CPS03SKG	Cinetto BASE Sliding System for Internal Doors Sliding Kit Set for Glass Doors. Includes 2x Upper Slides & 2 x Lower Slides	Set	-

SOFT CLOSE

CODE	DESCRIPTION	SOLD PER	LENGTH
CPS03SCIL	Cinetto BASE Sliding System for Internal Doors Soft Close Kit for Left Internal Door	Each	-
CPS03SCIR	Cinetto BASE Sliding System for Internal Doors Soft Close Kit for Right Internal Door	Each	-
CPS03SCEL	Cinetto BASE Sliding System for Internal Doors Soft Close Kit for Left External Door	Each	-
CPS03SCEL	Cinetto BASE Sliding System for Internal Doors Soft Close Kit for Right External Door	Each	-

UPPER/LOWER RAILS

CODE	DESCRIPTION	SOLD PER	LENGTH
CPS03R3	Cinetto Upper/Lower Rail for BASE & VELOCE	Length	3050mm

OPTIONAL ACCESSORIES

CODE	DESCRIPTION	SOLD PER	LENGTH
CPS03PL	Cinetto BASE Sliding System for Internal Doors Catch for Non Soft Close Doors	Each	-



VELOCE (PS06) SLIDING SYSTEM FOR HANGING DOORS



The Cinetto VELOCE is the perfect system for your wardrobe. Sitting concealed behind the pelmet, the doors hang on the top track and can be installed with optional soft close features. The VELOCE system can be installed with an optional bottom guide for added stability and movement.

Overview

- Easy to install
- To suit 18-50mm doors
- Up to 50kg wooden doors
- Available with soft close

Applications:

- Wardrobes
- Storage Closets

Specifications

- Track Length: 3050mm
- Door Thickness: 18mm-50mm
- Max Height: 2500mm
- Max Width: 500mm-1400mm
- Weight Capacity: 50kg per door
- \pm 5mm height adjustment

HOW TO ORDER

STEP 1

Select Number of Doors

- Door Kit
- Soft Close Device

STEP 2

Select Rails

- Upper rail
- Lower rail

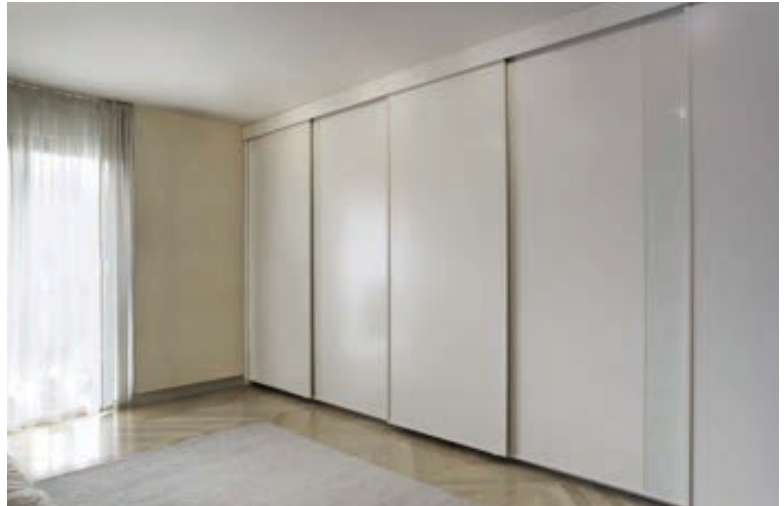

ORDER A CINETTO KIT:

Alternatively, you may choose to simply purchase a complete Cinetto kit.

See our website for full list of kits and further technical information: www.wilbrad.com.au

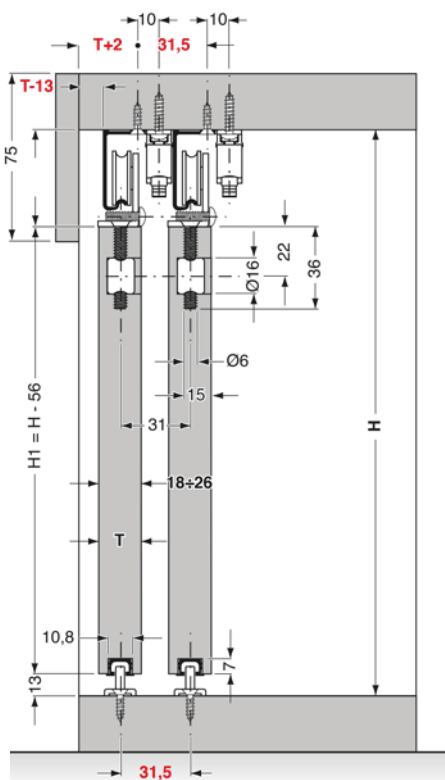

BUILT-IN APPLICATION

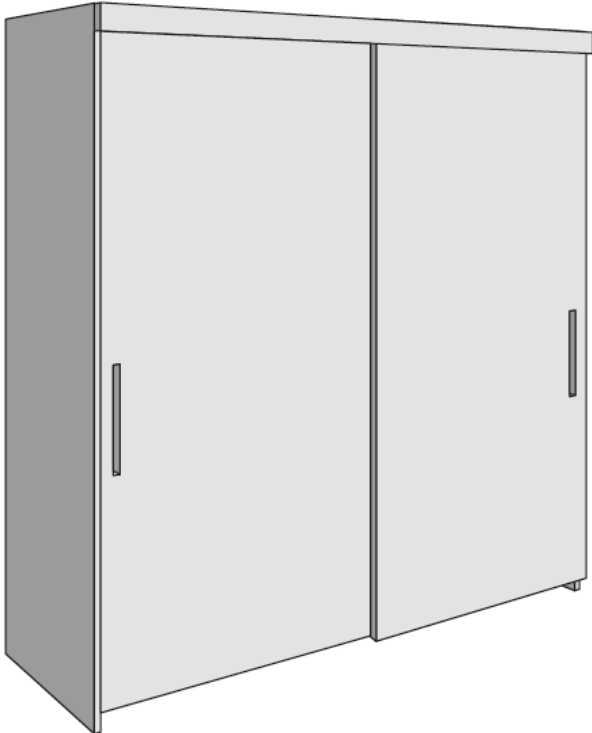

CABINET APPLICATION

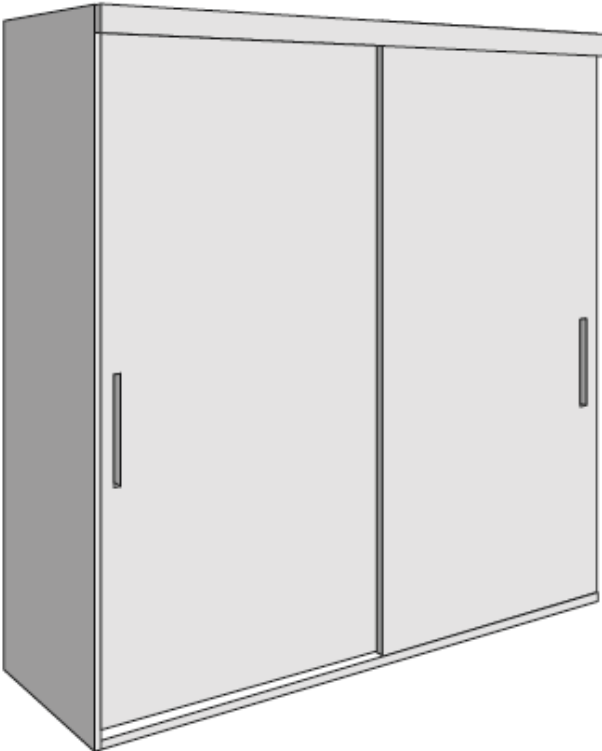

VELOCE COMPONENTS

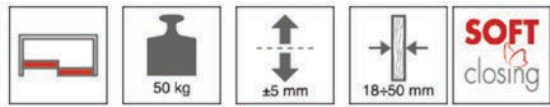

KITS

DOOR KITS

CODE	DESCRIPTION	SOLD PER	CAPACITY
CPS06DK	Cinetto VELOCE Sliding System for Hanging Doors Sliding Kit Set for Wooden Doors. Includes 2x Upper Slides & 2 x Lower Guides	Set	-

SOFT CLOSE

CODE	DESCRIPTION	SOLD PER	CAPACITY
CPS06SC	Cinetto VELOCE Sliding System for Hanging Doors Soft Close Device Kit	Each	-

RAILS

CODE	DESCRIPTION	SOLD PER	LENGTH
CPS06UR3	Cinetto VELOCE Sliding System for Hanging Doors Upper Rail. Length: 3050mm	Length	3050mm
CPS03R3	Cinetto Upper/Lower Rail Guide for BASE & VELOCE	Length	3050mm



INVISIBLE (PS08)

SLIDING SYSTEM WITH INVISIBLE RAILS



The Cinetto INVISIBLE is exactly that, Invisible!

With a rebated top and bottom track, this system allows you to create a clean-cut look where the track is not exposed, allowing your door fronts and application to be the centre of attention.

Overview

- Easy to install
- Rebated top and bottom track
- Able to suit any doors thicknesses. The only limitation is the weight of the door
- Up to 60kg wooden doors
- Available with soft-close
- +3 -2mm height adjustment

Applications:

- Wardrobes
- Storage Units
- Living Rooms

Specifications

- Track Length: 3050mm
- Door Thickness: n/a
- Max Height: 2800mm
- Max Width: 450mm-1400mm
- Weight Capacity: 60kg per door
- +3 -2mm height adjustment

HOW TO ORDER

STEP 1:

Select Number of Doors

- Door Kit

STEP 2:

Select Rails

- Upper Rail
- Lower Rail

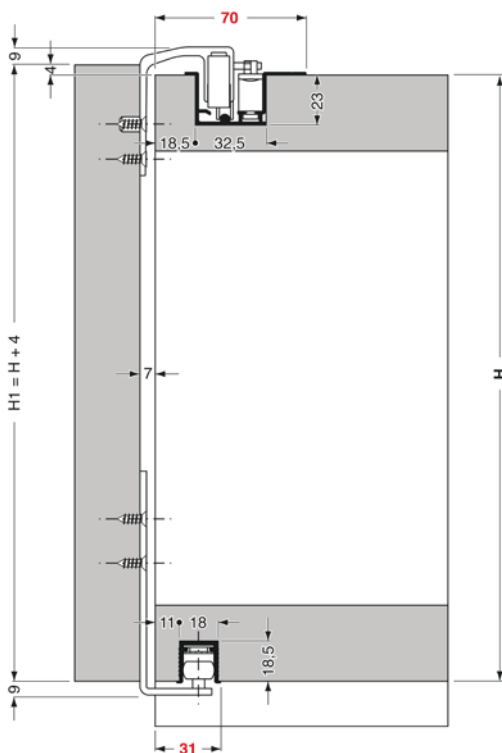

ORDER A CINETTO KIT:

Alternatively, you may choose to simply purchase a complete Cinetto kit.

See our website for full list of kits and further technical information: www.wilbrad.com.au

APPLICATION

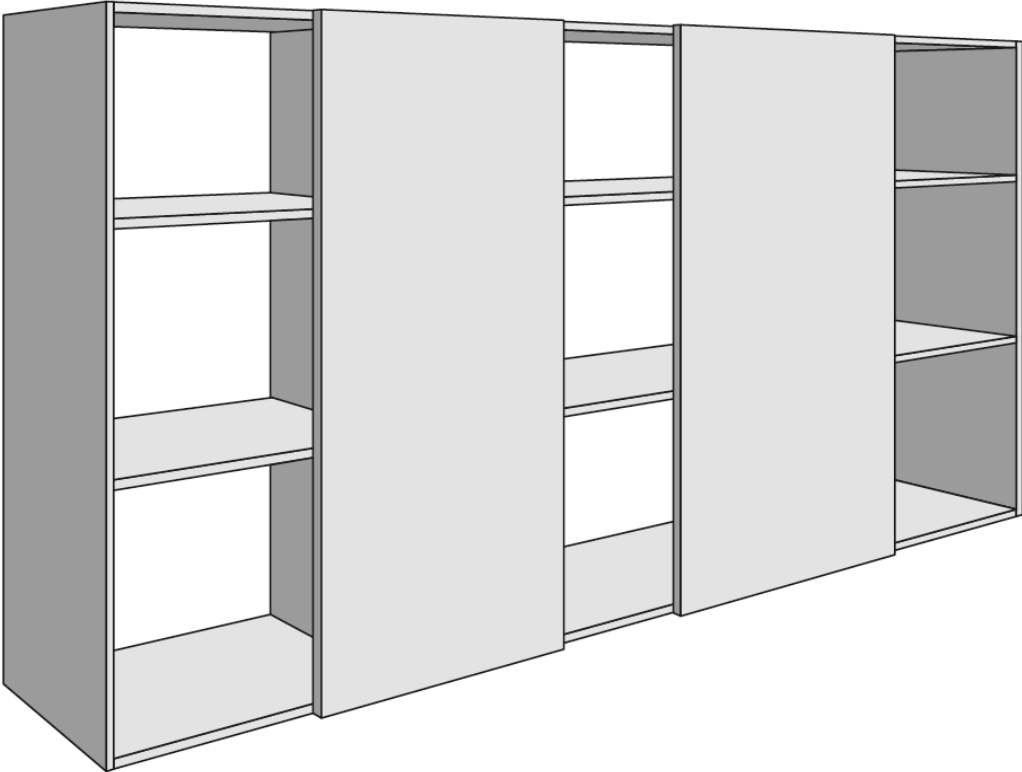
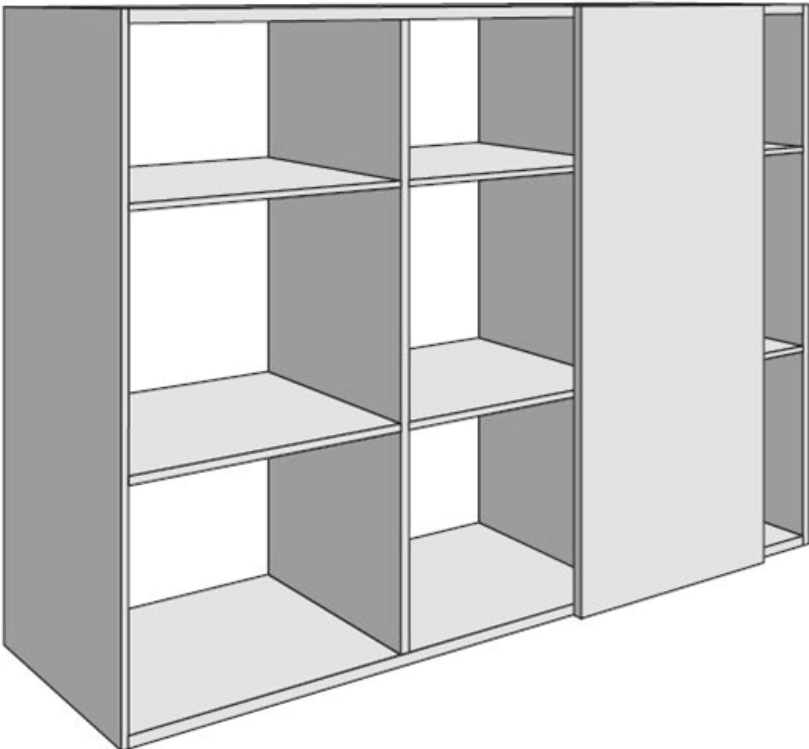

INVISIBLE COMPONENTS



CODES

DOOR KITS

CODE	DESCRIPTION	SOLD PER	LENGTH
CPS08DK	Cinetto INVISIBLE Sliding System with Invisible Doors Sliding Kit Set.	Set	-

RAILS

CODE	DESCRIPTION	SOLD PER	LENGTH
CPS08UR3	Cinetto INVISIBLE Sliding System with Invisible Doors Upper Rail. Length: 3050mm	Length	3050mm
CPS08LR3	Cinetto INVISIBLE Sliding System with Invisible Doors Lower Rail. Length: 3050mm	Length	3050mm



LIBRO MAXI (PS11)

SLIDING BI-FOLD SYSTEM



The Cinetto LIBRO MAXI Sliding Bi-Fold System is a quality, Italian system, with performance that exceeds other systems in the market.

Ideal for architects and designers who are constantly searching for the latest technology and innovative features for home design and functionality.

Overview

- Allows for creation of sliding systems with a completely flat façade
- Suitable for wooden doors
- Flexibility to choose number of doors and configurations

Applications:

- Wardrobes
- Kitchens
- Living Spaces
- Commercial Applications

Specifications

- Door Thickness: Min 16mm (18mm with Vertical Adjuster)
- ± 3 mm Vertical Adjustment
- Max Height: 3000mm
- Width of double doors: 600mm-1000mm
- Length: 3050mm rails
- Max Weight: 40kg per set of double doors

HOW TO ORDER

STEP 1:

Select Number of Doors

- Slide and Accessories Kit
- Coextruded Plastic Profile

STEP 2:

Select Rails

- Upper Track
- Lower Track

OPTIONAL:

Select Accessories

- Vertical Adjuster
- Door Straightener

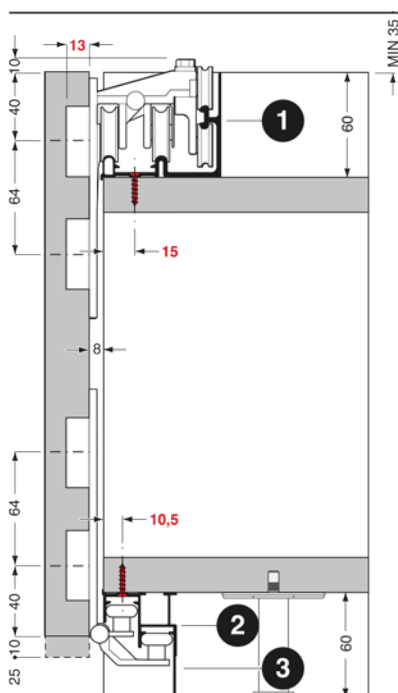

ORDER A CINETTO KIT:

Alternatively, you may choose to simply purchase a complete Cinetto kit.

See our website for full list of kits and further technical information: www.wilbrad.com.au

APPLICATION

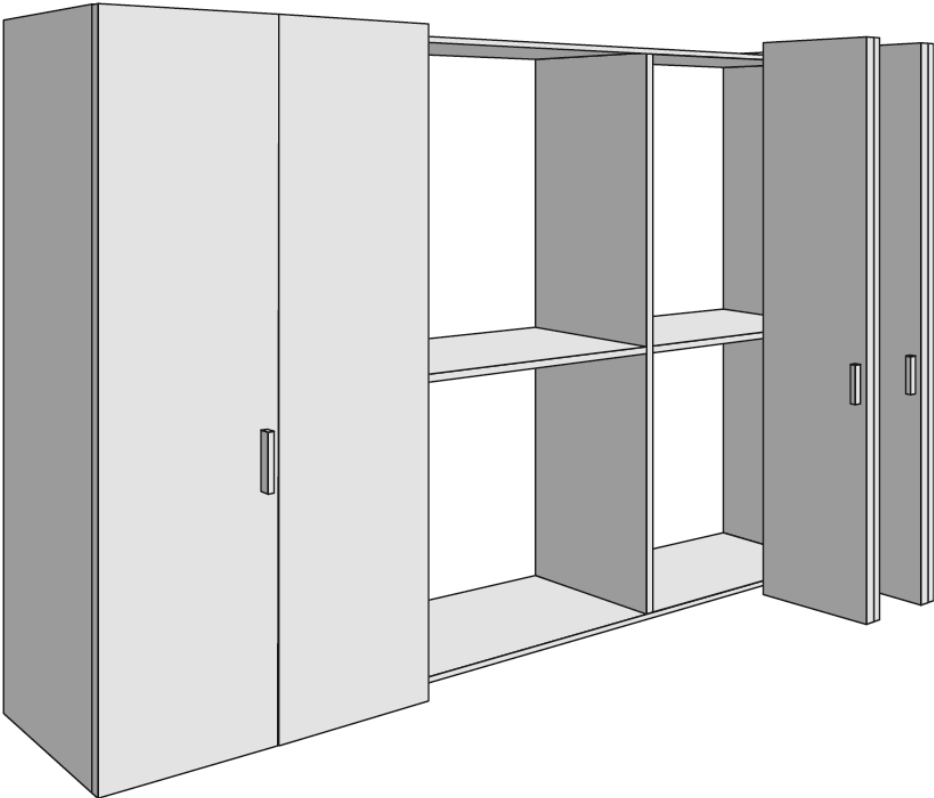
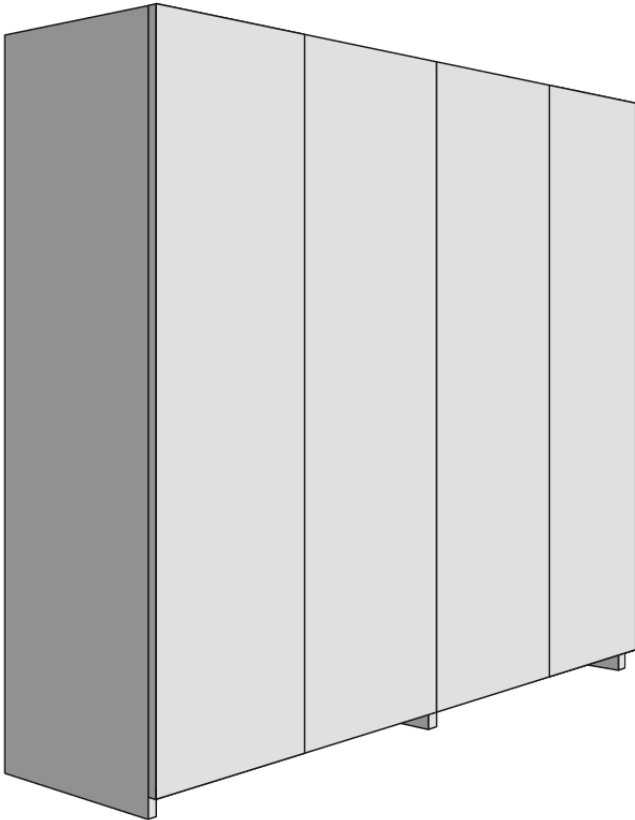

LIBRO MAXI (PS11) COMPONENTS

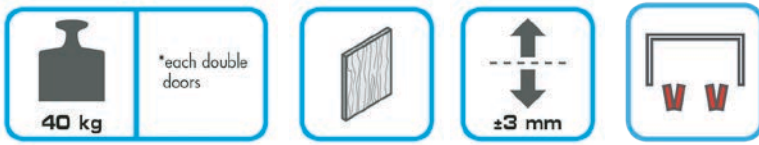

LIBRO BI-FOLD DOOR HARDWARE SET

CODE	DESCRIPTION	SOLD PER	LENGTH	COLOUR
CPS11AC	Cinetto LIBRO MAXI Sliding Bi-Fold System Slides and Accessories Kit for Pair Wooden Doors (Double Door Kit)	Set	-	-
CPS11PP	Cinetto LIBRO MAXI Sliding Bi-Fold System Coextruded Plastic Profile	Length	2600mm	Black

SELECT RAILS

CODE	DESCRIPTION	SOLD PER	LENGTH
CPS11UR3	Cinetto LIBRO MAXI Sliding Bi-Fold System Upper Track	Length	3050mm
CPS11LR3	Cinetto LIBRO MAXI Sliding Bi-Fold System Lower Track	Length	3050mm

OPTIONAL ACCESSORIES

CODE	DESCRIPTION	SOLD PER	LENGTH
CPS11AD	Cinetto LIBRO MAXI Sliding Bi Fold System Vertical Adjuster for Pair of Wooden Doors (Double Door Kit) optional	Set	-
CBR04DS	Cinetto Wooden Door Straightener. Top and Back Adjustment	Each	2175mm



IDEA (PS22)

ONE WAY SLIDING SYSTEM



IDEA is a one-way sliding system that can be applied to the front of a diverse range of applications.

Whether it is used on kitchen overheads, a TV setting or similar, the Cinetto IDEA provides flexibility, functionality, and the endless ability to create unique designs.

Overview

- One-way sliding system for rails and door frontally applied
- To suit wooden doors
- Possibility to create unique design trends
- Optional soft close

Applications:

- Kitchens
- Bathrooms
- Living Rooms
- Storage Units
- Buffet Units

Specifications

- To suit from 16mm door thickness
- To suit 16mm and 32mm carcass thickness
- Max Height: 1200mm *the door must be wider than higher*
- Max Length: 3050mm
- Min Door Thickness with Soft Close: 22mm
- Min Door Thickness without Soft Close: 16mm
- Min Door Width with 2 way Soft Close: 900mm
- Min Door Width without Soft Close: 400mm
- Vertical Adjustment: ± 3 mm
- Max Weight: 20kg per door

HOW TO ORDER

STEP 1:

Select Number of Doors

- Adjustable Slides Set
- Universal Soft Closing Device

STEP 2:

Select Rails

- Upper Track
- Lower Track
- End Caps
- Gasket Cover Fixing (only for 30mm)

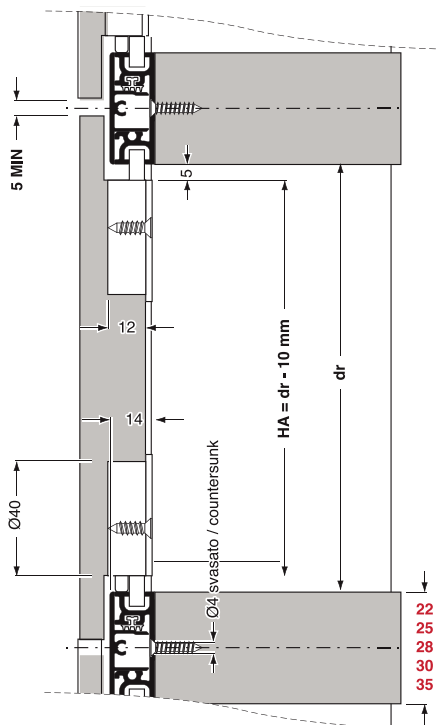

ORDER A CINETTO KIT:

Alternatively, you may choose to simply purchase a complete Cinetto kit.

See our website for full list of kits and further technical information: www.wilbrad.com.au

APPLICATION

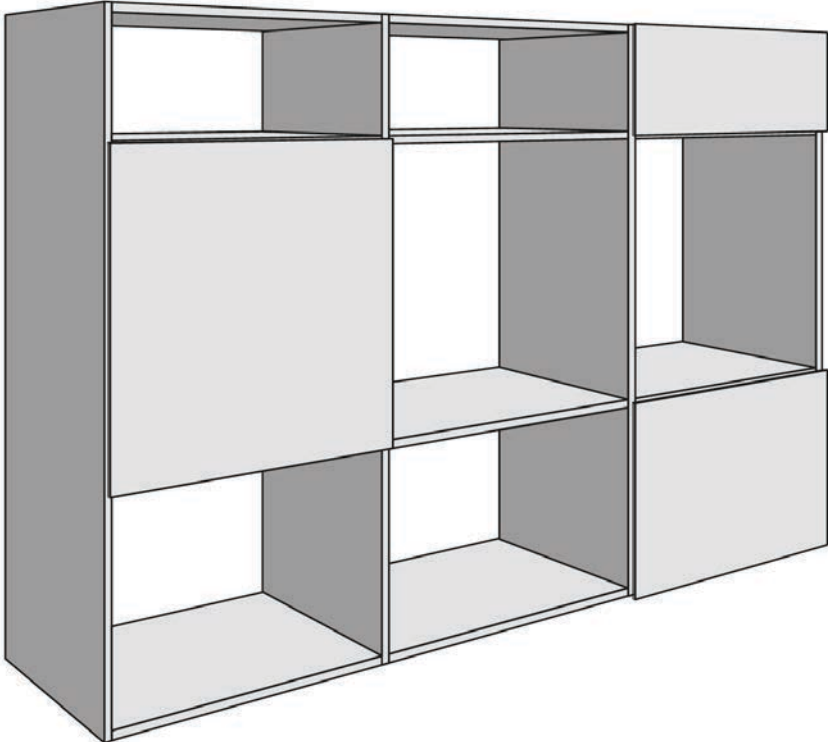
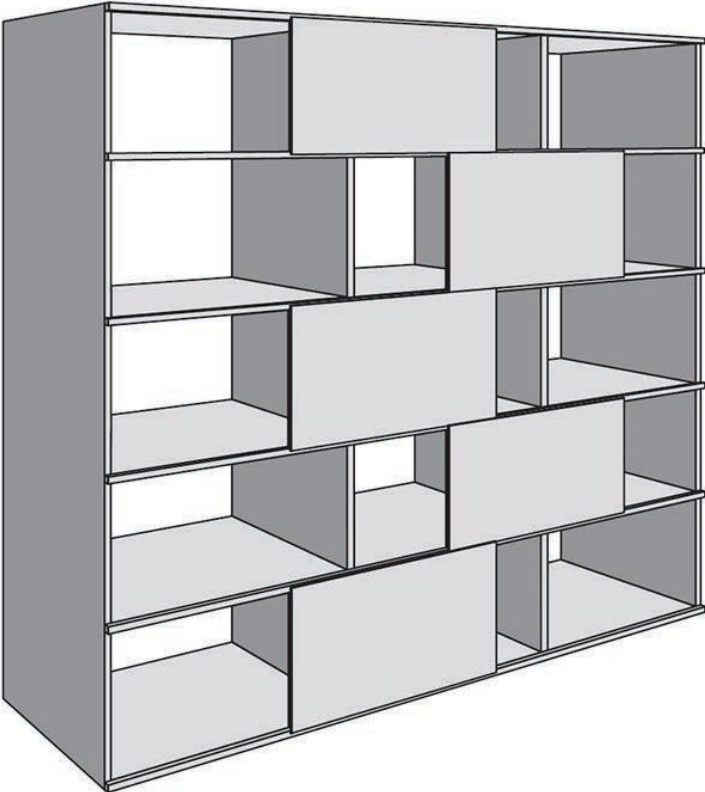

IDEA COMPONENTS (PS22)



1 DOOR HARDWARE SET (FOR 15MM)

CODE	DESCRIPTION	SOLD PER	CAPACITY
CPS22AS	Cinetto IDEA One Way Sliding System Adjustable Slides Set. Include 2x Upper Slides & 2x Lower Slides	Set	20kg
CPS22SC	Cinetto IDEA One Way Sliding System Soft Closing Device (Left and Right). Universal	Each	-

SELECT RAILS & ACCESSORIES (FOR 15MM)

CODE	DESCRIPTION	SOLD PER	SIZE
CPS22R15	Cinetto IDEA One Way Sliding System Upper/Lower Rail 15mm	Length	3050mm
CPS22CP15	Cinetto IDEA One Way Sliding System Cover Profile 15mm	Length	3050mm
CPS22HP15	Cinetto IDEA One Way Sliding System End Head Caps (Pair)	Set	15mm

1 DOOR HARDWARE SET (FOR 30MM)

CODE	DESCRIPTION	SOLD PER	CAPACITY
CPS22AS	Cinetto IDEA One Way Sliding System Adjustable Slides Set. Include 2x Upper Slides & 2x Lower Slides	Set	20kg
CPS22SC	Cinetto IDEA One Way Sliding System Soft Closing Device (Left and Right). Universal	Each	-

SELECT RAILS & ACCESSORIES (FOR 30MM)

CODE	DESCRIPTION	SOLD PER	SIZE
CPS22R30	Cinetto IDEA One Way Sliding System Upper/Lower Rail 30mm	Length	3050mm
CPS22CP30	Cinetto IDEA One Way Sliding System Cover Profile 30mm	Length	3050mm
CPS22CP30	Cinetto IDEA One Way Sliding System Gasket for Cover Fixing in the Rail	Length	3000mm
CPS22HP30	Cinetto IDEA One Way Sliding System End Head Caps (Pair)	Set	30mm



LIBRO (PS23) BI-FOLD DOOR SYSTEMS



The Cinetto LIBRO Bi-Fold Door System, with its premium Italian design, creates a statement when added to any setting.

Whether in wardrobes, European laundries or even pantries, the Cinetto LIBRO system operates as smooth as any other. Operating on ball bearing runners, the system can cater to options up to 50kg and its sturdy aluminium design ensures that it is fit for any project.

Overview

- Folding sliding system
- Suits timber or Aluminium framed glass doors
- Left hand roller & hinge moves to left when opening
- Right hand roller & hinge moves to right when opening
- Material: Aluminium (ALU)
- Available in anodised or black componentry

Applications:

- Wardrobes
- Kitchens
- Living Spaces
- European Laundry

Specifications

- 2 systems available, version to suit 25kg leaf and 50kg leaf
- Door thickness: 16-35mm
- Max Height:
 - 3000mm with bottom track
 - 2400mm without bottom track
- Max Width for 1 folding door:
 - 1200mm with bottom track
 - 900mm without bottom track
- Min Door Width: 400mm

Specifications change dependant on what runner set is chosen

HOW TO ORDER

STEP 1:

Select Number of Doors

- Upper Slide Kit
- Plastic Upper Slide Cover
- Centre Hinges

STEP 2:

Select Rails

- Upper Rail

OPTIONAL:

Select Accessories

- Lower Rail
- Lower Slide Kit
- Door Straightener



ORDER A CINETTO KIT:

Alternatively, you may choose to simply purchase a complete Cinetto kit.

See our website for full list of kits and further technical information: www.wilbrad.com.au

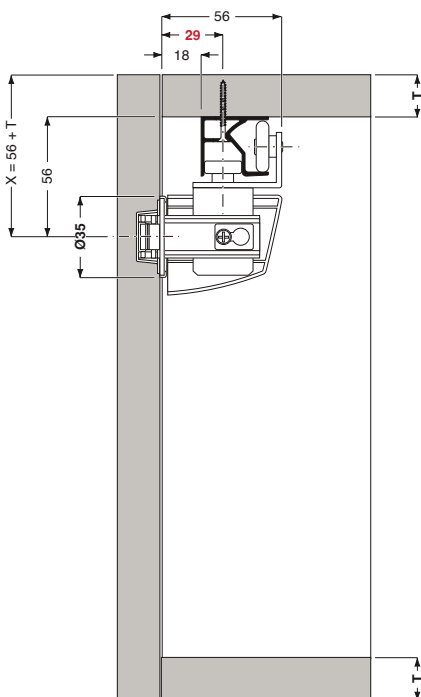

side elevation image for 25kg leaf

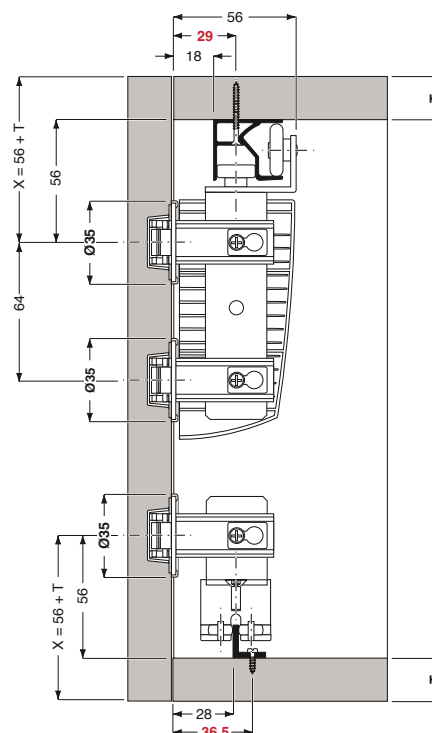

side elevation image for 50kg leaf

WOOD APPLICATION

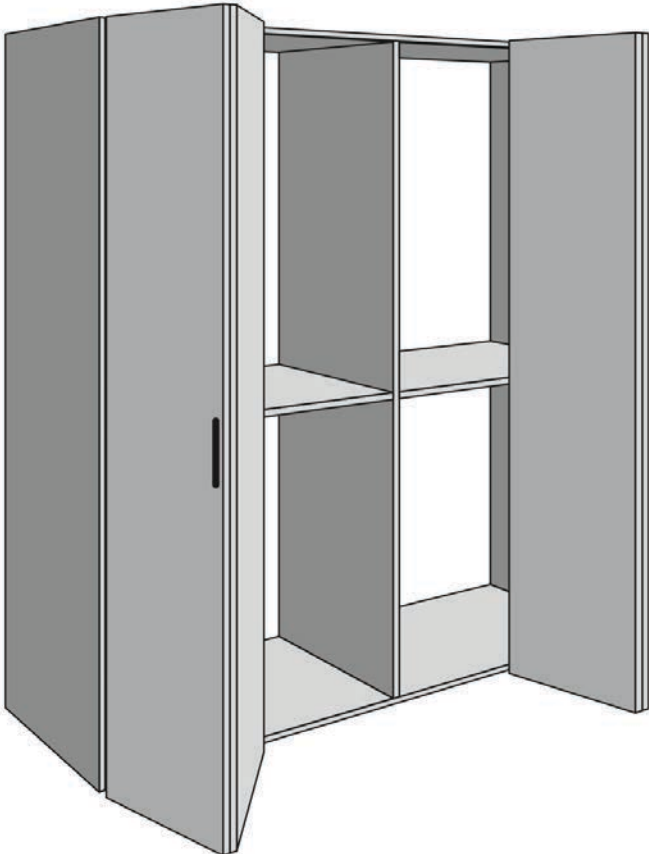
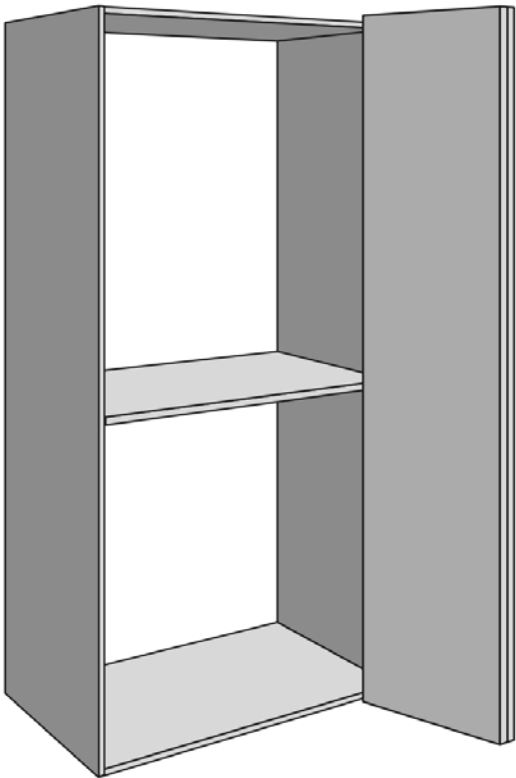
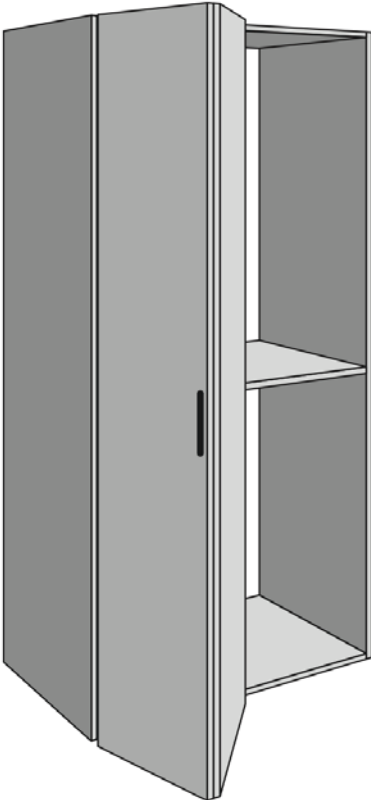

LIBRO (PS23) COMPONENTS



BI-FOLD DOOR HARDWARE SET

CODE	DESCRIPTION	COLOUR	SOLD PER	CAPACITY
CPS23USL	Cinetto LIBRO Bi-Fold Door System Left Hand Upper Slide Kit	-	Each	50kg
CPS23USR	Cinetto LIBRO Bi-Fold Door System Right Hand Upper Slide Kit	-	Each	50kg
CPS23URC	Cinetto LIBRO Bi-Fold Door System Plastic Cover for Upper Slide	Grey	Each	-
CPS23USL25	Cinetto LIBRO MINI Bi-Fold Door System Left Hand Upper Slide Kit	-	-	25kg
CPS23USR25	Cinetto LIBRO MINI Bi-Fold Door System Right Hand Upper Slide Kit	-	-	25kg
CPS23URC25	Cinetto LIBRO MINI Bi-Fold Door System Plastic Cover for Upper Slide	-	-	25kg
CPS23URCB	Cinetto LIBRO Bi-Fold Door System Plastic Cover for Upper Slide	Black	-	-

CENTRE HINGES

CODE	DESCRIPTION	COLOUR	SOLD PER
CASYM50	Cinetto Asymmetrical Hinge 50 x 42	Zinc Plated	Each
CASYM50B	Cinetto Asymmetrical Hinge 50 x 42	Black	Each
TKC382	Adjustable Centre Hinge For Concealed Folding Door Track	-	Each

SELECT RAILS

CODE	DESCRIPTION	COLOUR	SOLD PER	LENGTH
CPS23UR15	Cinetto LIBRO Bi-Fold Door System Upper Rail	Anodised Silver	Length	1500mm
CPS23UR3	Cinetto LIBRO Bi-Fold Door System Upper Rail	Anodised	Length	3050mm
CPS23UR3B	Cinetto LIBRO Bi-Fold Door System Upper Rail	Black	Length	3050mm

OPTIONAL

CODE	DESCRIPTION	COLOUR	SOLD PER	LENGTH
CPS23LR15	Cinetto LIBRO Bi-Fold Door System Lower Slide Kit	-	Length	1500mm
CPS23LR3	Cinetto LIBRO Bi-Fold Door System Lower Rail	-	Length	3050mm
CPS23LS	Cinetto LIBRO Bi-Fold Door System Lower Slide Kit	-	Each	-
CBR04DS	Cinetto Wooden Door Straightener. Top and Back Adjustment	-	Each	2175mm
CPS23LR3B	Cinetto LIBRO Bi-Fold Door System Lower Rail	Black	Length	3050mm



PIANO (PS40) COPLANAR SYSTEM



The Cinetto PIANO Coplanar System is 100% customisable. Thanks to the mechanism that incorporates all of the movements, the track can be cut to size according to the project's needs.

Cinetto's PIANO System allows you to create any type of combinations with 1, 2 or 3 doors. The PIANO System is customisable and compatible with B moved smart home technology.

Overview

- Aligned wardrobe panels providing a completely flush look when closed
- Soft opening and soft closing
- To suit wooden doors and with aluminium framed doors
- Numbers of doors: up to 3 doors
- Compatible with B-moved
- Handle Profiles available

Applications:

- Wardrobes
- Storage Cabinets
- Commercial Applications
- Living/TV Cabinets

Specifications

- Track Length: 2m and 4m
- Max Height: 3000mm
- Width of each door (2 doors): min 890mm, max 1800 mm
- Width of each door (3 doors): min 1300 mm, max 1800 mm (Check track length availability for max door widths)
- Doors thickness: min 16 mm, max 43 mm (55mm including handles)
- Adjustment of the door height: ± 6 mm
- Weight Capacity:
 - 2 Door Systems: Max 60 kg
 - 3 Door Systems: Max 45kg for outer doors, 100kg for middle doors
- B Moved only available in 1 or 2 door applications

HOW TO ORDER

STEP 1:

Select Number of Doors

- 1 Door System Slide Kit
- 2 Door System Slide Kit
- 3 Door System Slide Kit
- Slide Adapters

STEP 2:

Select Rails

- Upper Rail
- Lower Rail
- Cover Profile

STEP 3:

Optional Accessories:

- Door Straightener
- Handle Profile
- Edge Cover Profile
- Dust Brush Profile

STEP 4:

Compatible with B-moved® Electrical System!

- Upper Rail
- Connector Brackets
- Electronic Unit
- Motion Transmission Bars

Add: For Wave Sensor

- Wave Sensor
- Wave Sensor Receiver Unit

Add: For Smart Home Compatibility

- Aux Control Input



ORDER A CINETTO KIT:

Alternatively, you may choose to simply purchase a complete Cinetto kit.

See our website for full list of kits and further technical information: www.wilbrad.com.au

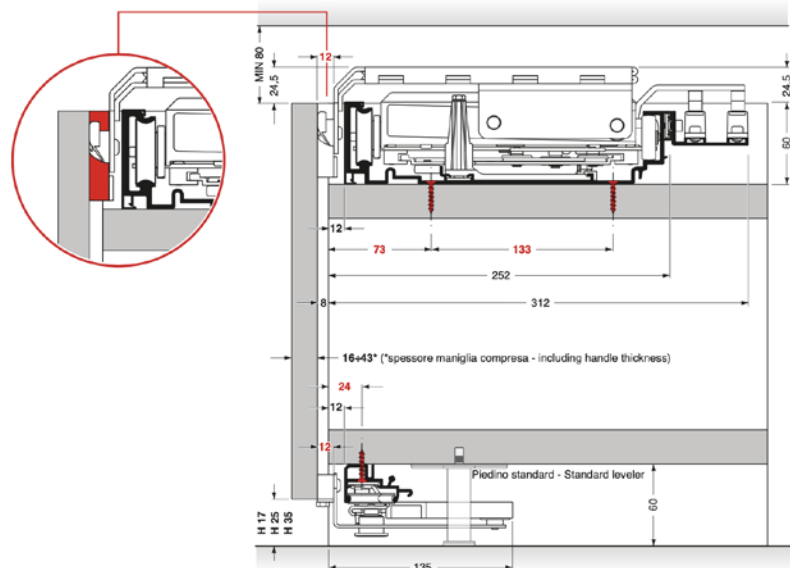

PIANO (PS40) SYSTEM APPLICATIONS

1 DOOR

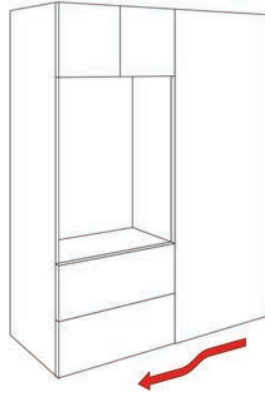

2 DOORS

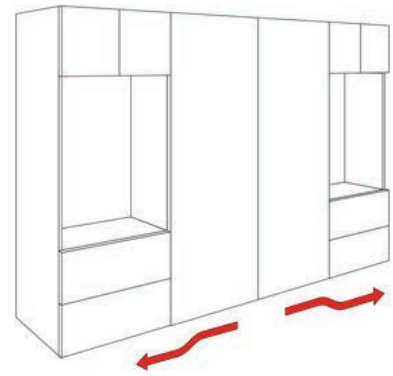
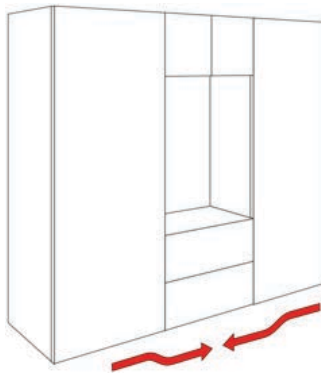
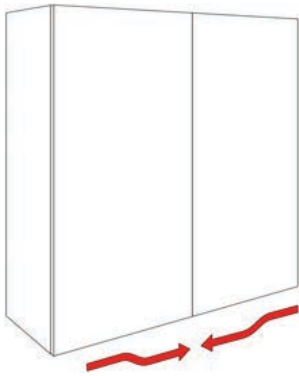

3 DOORS

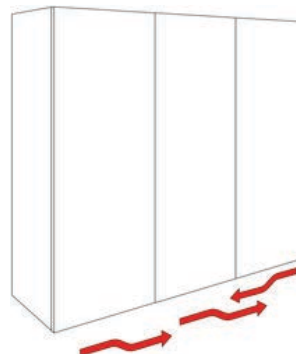
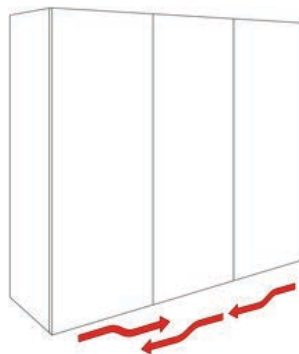

PIANO (PS40) COMPONENTS



SLIDE KITS AND ADAPTERS:

FOR 2 DOOR SYSTEMS

CODE	DESCRIPTION	SOLD PER	CAPACITY
CPS40SRH3	Cinetto PIANO Coplanar Door System Slides Kit for Right Hand Door. 2 & 3 Door Wardrobe.	Each	45kg per outer door 100kg per middle door
CPS40SLH3	Cinetto PIANO Coplanar Door System Slides Kit for Left Hand Door. 2 & 3 Door Wardrobe.	Each	45kg per outer door 100kg per middle door
CPS40SRH2	Cinetto PIANO Coplanar Door System Slides Kit for Right Hand Door. 2 Door Wardrobe.	Each	60kg per door
CPS40SLH2	Cinetto PIANO Coplanar Door System Slides Kit for Left Hand Door. 2 Door Wardrobe.	Each	60kg per door

FOR 3 DOOR SYSTEMS

CODE	DESCRIPTION	SOLD PER	CAPACITY
CPS40SRH3	Cinetto PIANO Coplanar Door System Slides Kit for Right Hand Door. 2 & 3 Door Wardrobe.	Each	45kg per outer door 100kg per middle door
CPS40SLH3	Cinetto PIANO Coplanar Door System Slides Kit for Left Hand Door. 2 & 3 Door Wardrobe.	Each	45kg per outer door 100kg per middle door
CPS40URC	Cinetto PIANO Coplanar Door System Cover for Upper Slide	Each	-

ADAPTERS

CODE	DESCRIPTION	SOLD PER
CPS40SA	Cinetto PIANO Coplanar Door System Slide Adapters to suit Wooden Doors	Set

PIANO (PS40) COMPONENTS



SELECT RAILS

UPPER RAIL

CODE	DESCRIPTION	SOLD PER	LENGTH
CPS40UR2	Cinetto PIANO Coplanar Door System Upper Rail	Length	2000mm
CPS40UR4	Cinetto PIANO Coplanar Door System Upper Rail	Length	4000mm
CPS40CP2	Cinetto PIANO Coplanar Door System Cover Profile for Upper Rail	Length	2000mm
CPS40CP4	Cinetto PIANO Coplanar Door System Cover Profile for Upper Rail	Length	4000mm

LOWER RAIL

CODE	DESCRIPTION	SOLD PER	LENGTH
CPS40LR2	Cinetto PIANO Coplanar Door System Lower Rail	Length	2000mm
CPS40LR4	Cinetto PIANO Coplanar Door System Lower Rail	Length	4000mm

HANDLE PROFILES

CODE	DESCRIPTION	SOLD PER	LENGTH
CPS40HP	Cinetto PIANO Coplanar Door System Handle Profile A to suit 18mm and 25mm.	Length	3050mm
CPS40ECP	Cinetto PIANO Coplanar Door System Edge Cover Profile B for Handle Profile to suit 18mm Handle Profile.	Length	3050mm
CPS40DBP	Cinetto Dust Brush Profile for Handle Profiles 5mm.	Length	3000mm

OPTIONAL ACCESSORIES

CODE	DESCRIPTION	SOLD PER	LENGTH
CBR04DS	Cinetto Wooden Door Straightener. Top and Back Adjustment	Each	2175mm

PIANO B-moved® COMPONENTS



RAILS AND CONNECTORS:

CODE	DESCRIPTION	SOLD PER	LENGTH
CPS40UR2B	Cinetto PIANO Coplanar Door System B-moved® Upper Rail.	Length	2000mm
CPS40UR4B	Cinetto PIANO Coplanar Door System B-moved® Upper Rail	Length	4000mm
CPS40URBB	Cinetto PIANO Coplanar Door System B-moved® Connector Brackets for Upper Slide. Left and Right Brackets.	Set	-

B-moved® ELECTRICAL COMPONENTS

MOTION TRANSMISSION BARS

CODE	DESCRIPTION	SOLD PER	DOOR WIDTHS
BMOVETBA	Cinetto B-moved® Motion Transmission Bar for 2 Door Systems.	Each	888 - 1296mm
BMOVETBB	Cinetto B-moved® Motion Transmission Bar for 2 Door Systems.	Each	1154 - 1800mm

B-moved® ELECTRONIC UNIT

CODE	DESCRIPTION	SOLD PER
BMOVEUNIT	Cinetto B-moved® Electronic Unit with Remote Control	Each

ADD: FOR WAVE SENSOR COMPATIBILITY

CODE	DESCRIPTION	SOLD PER
BMOVEWUNI	Cinetto B-moved® Wave Sensor Receiver Unit	Each
BMOVEWSEN	Cinetto B-moved® Wave Sensor with Assembling Accessory	Each

ADD: FOR SMART HOME COMPATIBILITY

CODE	DESCRIPTION	SOLD PER
BMOVECONT	Cinetto B-moved® Connector for Aux Control Input	Each



VOLO (PS48)

SLIDING SYSTEM FOR OVERLAPPING DOORS



Exclusive to Wilson and Bradley, the Cinetto VOLO Sliding System for Overlapping Doors provides an industry standard in terms of quality Italian design.

The incredibly silent and smooth functionality, alongside the ability to be equipped with the Cinetto B-moved® system, presents an industry first innovation.

Overview

- Sliding System for Overlapping Doors
- Frontal Adjustment
- Suitable for wooden and aluminium frame doors
- Smooth and silent functionality
- Compatible with B-moved®
- Handle Profiles available

Applications:

- Wardrobes
- Storage Cabinets
- Commercial Applications
- Living/TV Cabinets

Specifications

- Track Length: 2m-4m
- Max Height: 3000mm
- Doors thickness: to suit 18mm-32mm board
- Adjustment of the door: ± 6 mm
- Weight Capacity: 80kg per door

HOW TO ORDER

STEP 1:

Select Number of Doors

- Internal Door Slide Kit
- External Door Slide Kit
- Soft Close
- Soft Close Activators

STEP 2:

Select Rails

- Upper Rail
- Lower Rail
- Cover Profile

STEP 3:

Optional Accessories:

- Door Straightener
- Handle Profile
- Dust Brush Profile



STEP 4:

Compatible with B Moved Electrical System!

- Upper Rail
- Connector Brackets
- Electronic Unit
- Motion Transmission Bars

Add: For Wave Sensor

- Wave Sensor
- Wave Sensor Receiver Unit

Add: For Smart Home Compatibility

- Aux Control Input

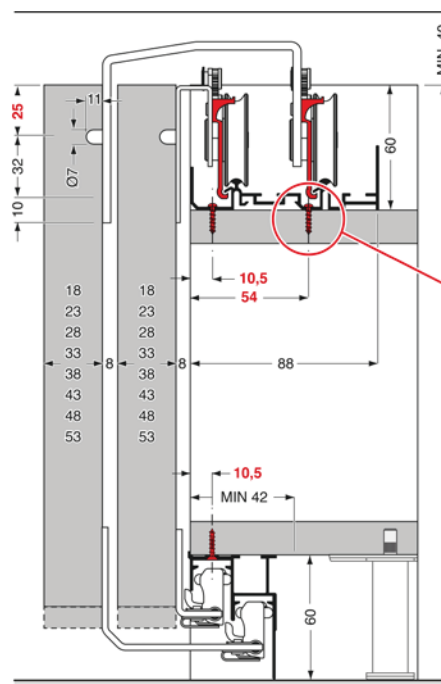

APPLICATION

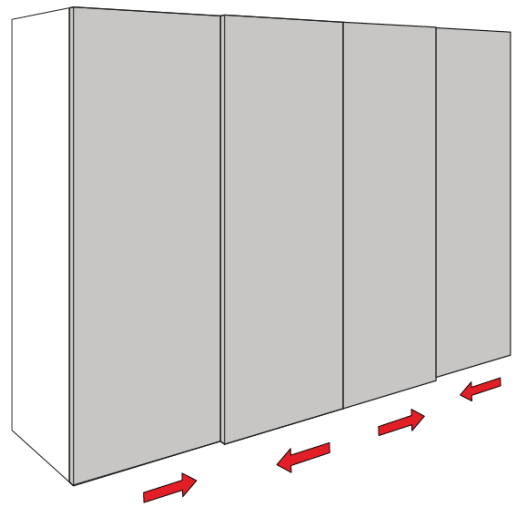
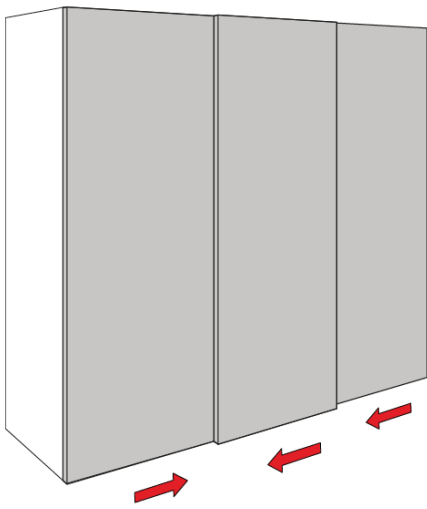
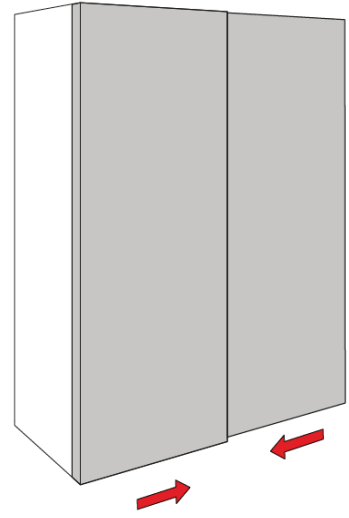
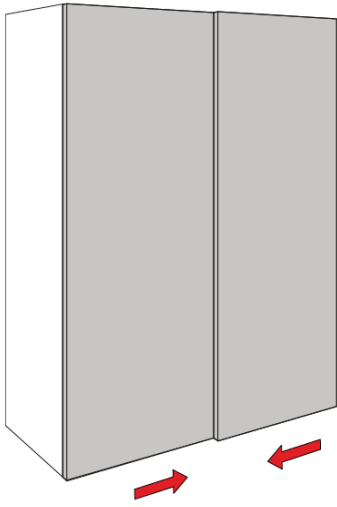

VOLO (PS48) COMPONENTS

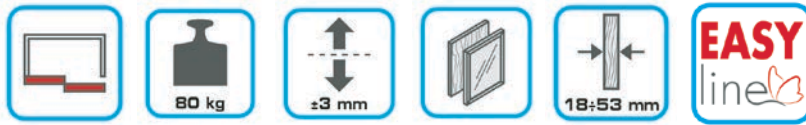

SELECT SLIDE SETS & SOFT CLOSE

INTERNAL DOOR SLIDES

CODE	DESCRIPTION	SOLD PER	CAPACITY
CPS48IS	Cinetto VOLO Sliding System for Overlapping Doors Wheel Kit Slides for Internal Door.	Set	80kg

EXTERNAL DOOR SLIDES

CODE	DESCRIPTION	SOLD PER	TO SUIT	CAPACITY
CPS48ES18	Cinetto VOLO Sliding System for Overlapping Doors Wheel Kits Slides for External Door.	Set	18mm Board	80kg
CPS48ES25	Cinetto VOLO Sliding System for Overlapping Doors Wheel Kits Slides for External Door.	Set	25mm Board	80kg
CPS48ES32	Cinetto VOLO Sliding System for Overlapping Doors Wheel Kits Slides for External Door.	Set	32mm Board	80kg

SOFT CLOSE

CODE	DESCRIPTION	SOLD PER	CAPACITY
CPS48SC	Cinetto VOLO Sliding System for Overlapping Doors Soft Closing Kit for Left and Right Hand Doors.	Each	50kg
CPS48CSC	Cinetto VOLO Sliding System for Overlapping Doors Central Soft Closing Kit. For 3 Door Systems.	Each	50kg
CPS48SCAR	Cinetto VOLO Sliding System for Overlapping Doors Right Activator Kit for Soft Closing.	Each	-
CPS48SCAL	Cinetto VOLO Sliding System for Overlapping Doors Left Activator Kit for Soft Closing.	Each	-

VOLO (PS48) COMPONENTS



SELECT RAILS

UPPER RAIL

CODE	DESCRIPTION	SOLD PER	LENGTH
CPS48UR2	Cinetto VOLO Sliding System for Overlapping Doors Upper Rail.	Length	2000mm
CPS48UR4	Cinetto VOLO Sliding System for Overlapping Doors Upper Rail.	Length	4000mm
CPS48CP3	Cinetto VOLO Dust Cover Profile. For Sliding System for Overlapping Doors and Coplanar System.	Length	3000mm

LOWER RAIL

CODE	DESCRIPTION	SOLD PER	LENGTH
CPS48LR2	Cinetto VOLO Sliding System for Overlapping Doors Lower Rail.	Length	2000mm
CPS48LR4	Cinetto VOLO Sliding System for Overlapping Doors Lower Rail.	Length	4000mm

HANDLE PROFILES

CODE	DESCRIPTION	SOLD PER	TO SUIT	LENGTH
CPS48NHP	Cinetto VOLO Sliding System for Overlapping Doors Narrow Handle Profile.	Length	18mm Doors.	2650mm
CPS48WHP	Cinetto VOLO Sliding System for Overlapping Doors Wide Handle Profile.	Length	18mm Doors.	2650mm
CPS48OHP	Cinetto VOLO Sliding System for Overlapping Doors Opposite Handle Profile.	Length	18mm Doors.	2650mm
CPS40DBP	Cinetto Dust Brush Profile for Handle Profiles 5mm.	Length	-	3000mm

OPTIONAL ACCESSORIES

CODE	DESCRIPTION	SOLD PER	LENGTH
CBR04DS	Cinetto Wooden Door Straightener. Top and Back Adjustment	Length	2175mm

VOLO B-moved[®] COMPONENTS



RAILS AND CONNECTORS

CODE	DESCRIPTION	SOLD PER	LENGTH
CPS48UR4B	Cinetto VOLO Sliding System for Overlapping Doors Upper Rail for B-moved [®] .	Length	4000mm
CPS48CBL2	Cinetto VOLO Sliding System for Overlapping Doors B-moved [®] Connector Brackets for Upper Rail. For 2 Right External Doors.	Set	-
CPS48CBR2	Cinetto VOLO Sliding System for Overlapping Doors B-moved [®] Connector Brackets for Upper Rail. For 2 Left External Doors.	Set	-
CPS48CB3	Cinetto VOLO Sliding System for Overlapping Doors B-moved [®] Connector Brackets for Upper Rail. For 3 Doors.	Set	-

B-moved[®] ELECTRICAL COMPONENTS:

MOTION TRANSMISSION BARS

CODE	DESCRIPTION	SOLD PER
BMOVETBA	Cinetto B-moved [®] Motion Transmission Bar for 2 Door Systems. Door Widths: 888 -1296mm	Each
BMOVETBB	Cinetto B-moved [®] Motion Transmission Bar for 2 Door Systems. Door Widths: 1154 -1800mm	Each

B-moved[®] ELECTRONIC UNIT

CODE	DESCRIPTION	SOLD PER
BMOVEUNIT	Cinetto B-moved [®] Electronic Unit with Remote Control	Each

ADD: FOR WAVE SENSOR COMPATIBILITY

CODE	DESCRIPTION	SOLD PER
BMOVEWUNI	Cinetto B-moved [®] Wave Sensor Receiver Unit	Each
BMOVEWSEN	Cinetto B-moved [®] Wave Sensor with Assembling Accessory	Each

ADD: FOR SMART HOME COMPATIBILITY

CODE	DESCRIPTION	SOLD PER
BMOVECONT	Cinetto B-moved [®] Connector for Aux Control Input	Each



AGILE (PS60)

FLOOR SLIDING FOR SINGLE SIDE DOORS



Exclusive to Wilson and Bradley, the Cinetto AGILE Floor Sliding System presents another premium Italian design solution.

Using the bottom rollers and soft close technology, the AGILE is easy to assemble, and provides effortless functionality. The AGILE can also accommodate heavy doors, allowing for more bespoke design options.

Overview

- Floor Sliding System for Single Sided Doors
- To suit Wooden Doors
- Handle Profile available (to suit 18mm board)
- 1 or 2 way soft close

Applications:

- Wardrobes
- Storage cabinets
- Other living spaces

Specifications

- 2,3 and 4 Door Applications
- Max Height: 3000mm
- Max Door Width: 18mm
- Track Length: 3050mm
- Vertical Adjustment ± 6 mm
- Weight Capacity:
 - 60kg with Soft Close
 - 100kg without Soft Close

HOW TO ORDER

STEP 1:

Select Number of Doors

- Adjustable Lower Slides
- Soft Close
- Soft Close Activators

STEP 2:

Select Rails

- Upper Track
- Lower Track



STEP 3:

Optional Accessories:

- Door Straightener
- Handle Profile
- Dust Brush Profile

ORDER A CINETTO KIT:

Alternatively, you may choose to simply purchase a complete Cinetto kit.

See our website for full list of kits and further technical information: www.wilbrad.com.au

TOP & BOTTOM FIXED APPLICATION

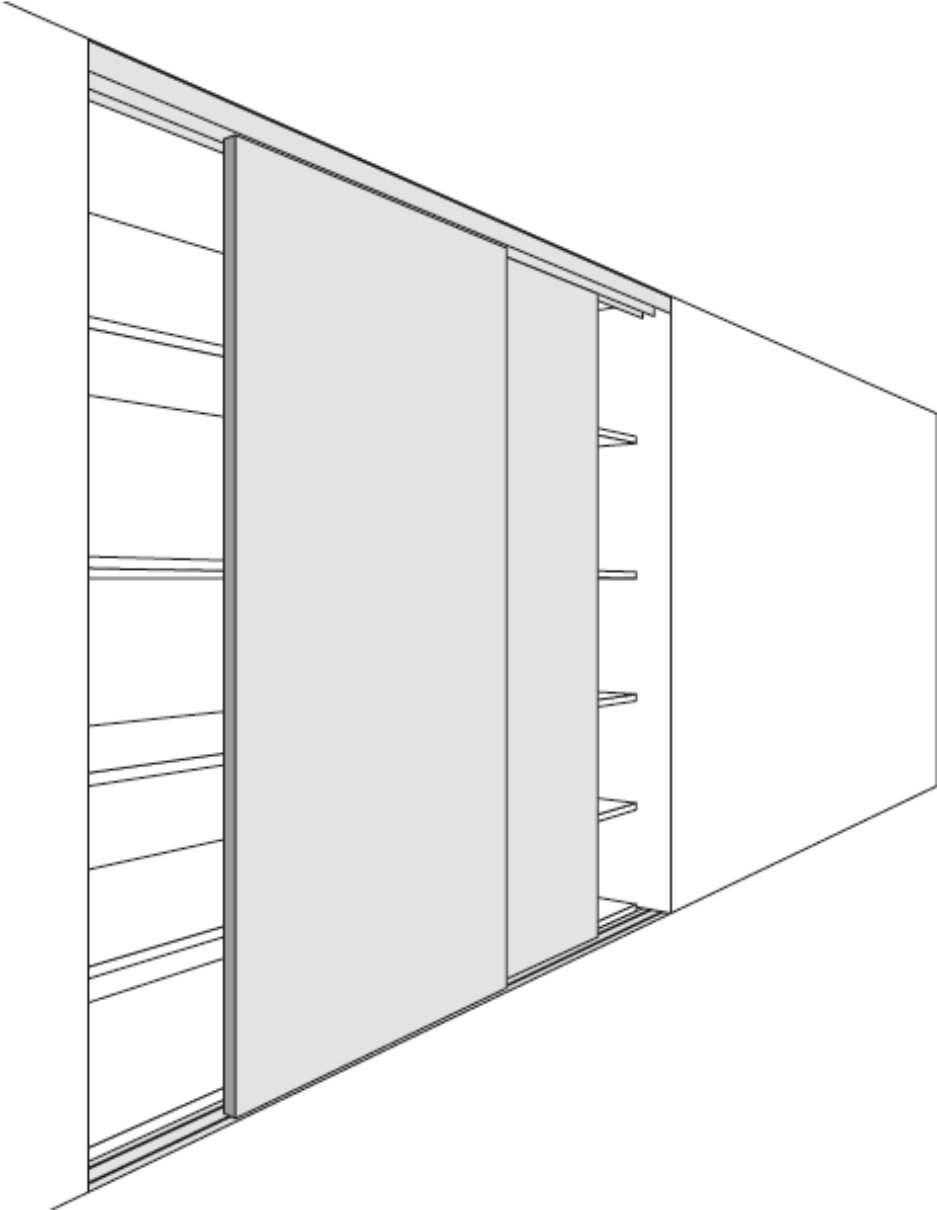

AGILE (PS60) COMPONENTS



DOOR HARDWARE SET

WHEELS

CODE	DESCRIPTION	SOLD PER	CAPACITY
CPS60ALS	Cinetto AGILE Floor Sliding System for Single Sided Doors. Adjustable Lower Slide.	Each	100kg

SOFT CLOSE

CODE	DESCRIPTION	SOLD PER	CAPACITY
CPS60SCR	Cinetto AGILE Floor Sliding System for Single Sided Doors. Upper Slide with Soft Close. Right Hand.	Each	60kg
CPS60SCL	Cinetto AGILE Floor Sliding System for Single Sided Doors. Upper Slide with Soft Close. Left Hand.	Each	60kg
CPS60SCA	Cinetto AGILE Floor Sliding System for Single Sided Doors. Activator Kit for Soft Closing Device.	Each	-

SELECT RAILS

CODE	DESCRIPTION	SOLD PER	LENGTH
CPS60UR3	Cinetto AGILE Floor Sliding System for Single Sided Doors. Two Way Upper Rail.	Length	3050mm
CPS60LR3	Cinetto AGILE Floor Sliding System for Single Sided Doors. Two Way Lower Rail.	Length	3050mm

HANDLE PROFILES

CODE	DESCRIPTION	SOLD PER	LENGTH
CPS60HP	Cinetto AGILE Floor Sliding System for Single Sided Doors Handle Profile. To suit 18mm Doors.	Length	2650mm
CPS60DBP	Cinetto Dust Brush Profile for Handle Profiles 9mm.	Length	3000mm

OPTIONAL ACCESSORIES

CODE	DESCRIPTION	SOLD PER	LENGTH
CBR04DS	Cinetto Wooden Door Straightener. Top and Back Adjustment	Each	2175mm



MAGICO (PS66) SLIDING SYSTEM FOR RETRACTABLE DOORS

MADE IN ITALY

The Cinetto MAGICO allows you to obtain a clean and linear result thanks to innovative technology that works without upper and lower rails. The Cinetto MAGICO is the perfect application for walk-in closets or an entryway to a butler's pantry. It can also be used to convert one space into two separate rooms.

Overview

- Designed to suit 25 - 40mm doors
- Up to 50kg wooden doors
- Soft-close
- ± 3 mm height adjustment

Applications:

- Butlers Pantry
- Walk in wardrobes

Specifications

- Door Thickness: 25mm-40mm
- Height: 2400mm-2700mm
- Width: 600mm-1000mm
- Weight Capacity: 50kg per door
- ± 3 mm height adjustment

HOW TO ORDER

STEP 1:

Select Doors

- Left Door
- Right Door

STEP 2:

Select Assembly Kit and System



ORDER A CINETTO KIT:

Alternatively, you may choose to simply purchase a complete Cinetto kit.

See our website for full list of kits and further technical information: www.wilbrad.com.au

APPLICATION

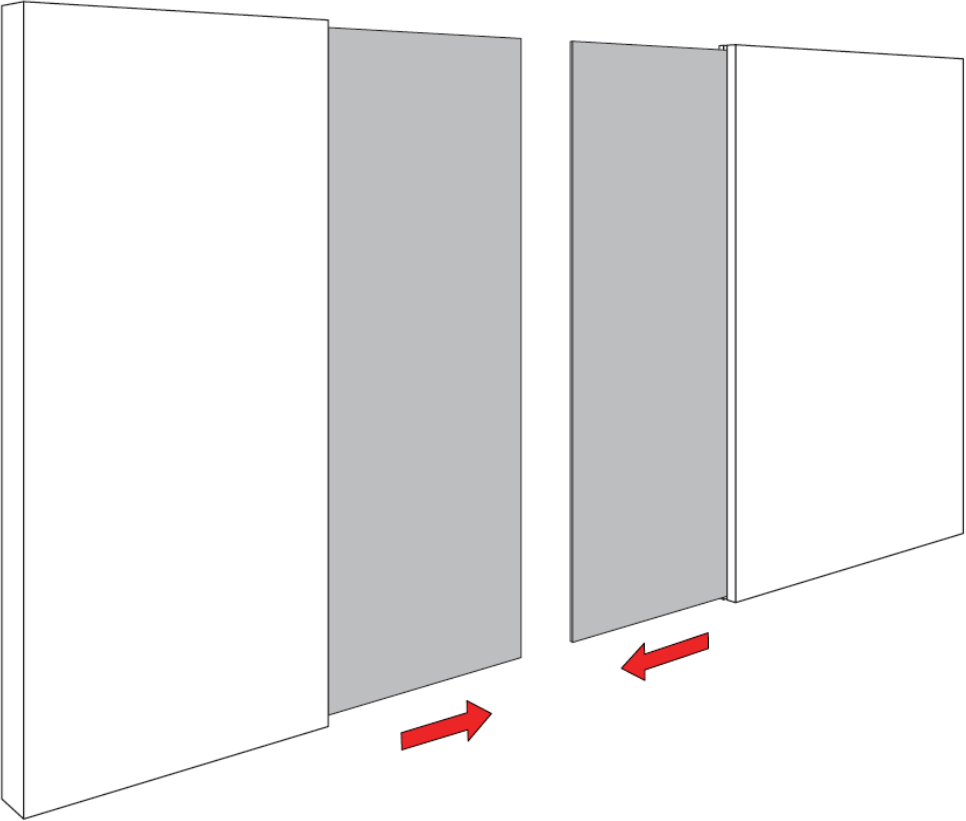
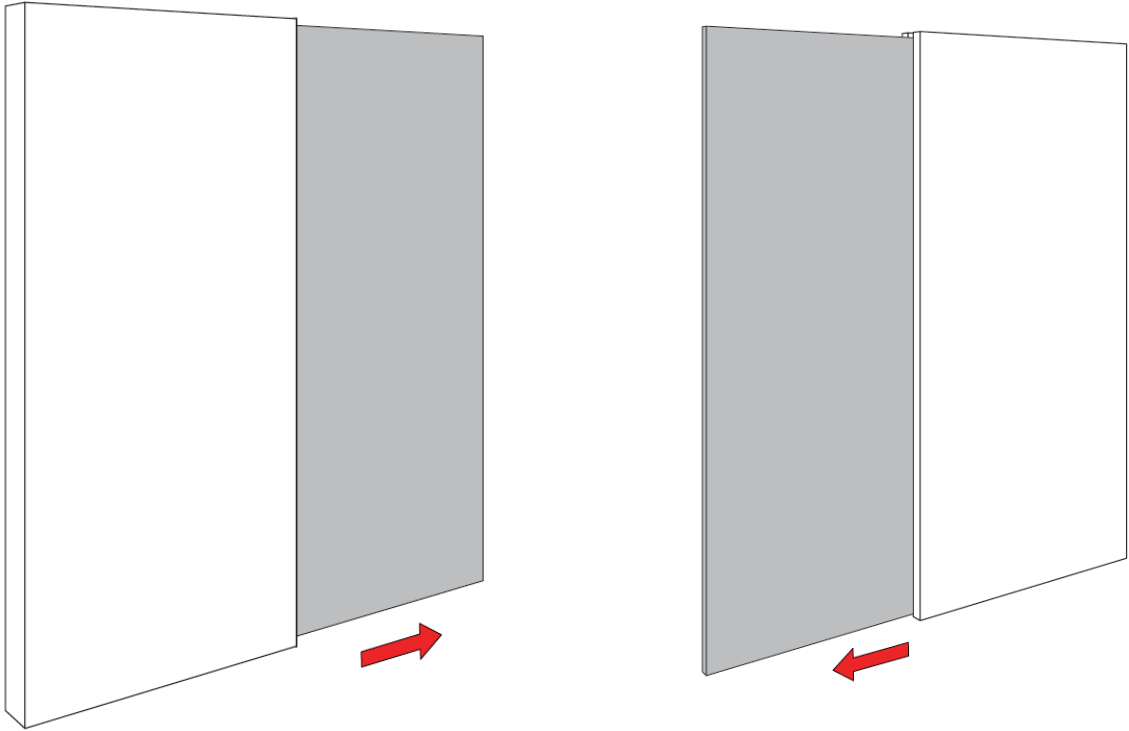

MAGICO COMPONENTS

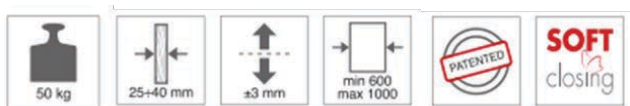

TECHNICAL DETAILS

LEFT HAND DOOR

CODE	DESCRIPTION	SOLD PER	HEIGHT
CPS66SYLM	Cinetto MAGICO Sliding System for Retractable Doors Left Hand System.	Each	2400-2700mm
CPS66AKLM	Cinetto MAGICO Sliding System for Retractable Doors Left Hand Assembly Kit.	Each	2400-2700mm

RIGHT HAND DOOR

CODE	DESCRIPTION	SOLD PER	HEIGHT
CPS66SYRM	Cinetto MAGICO Sliding System for Retractable Doors Right Hand System.	Length	2400-2700mm
CPS66AKRM	Cinetto MAGICO Sliding System for Retractable Doors Right Hand Assembly Kit.	Length	2400-2700mm



ADJUSTABLE DOOR STRAIGHTENER (BR04)



The Cinetto Door Straightener System allows for creativity and flexibility in customizing your sliding door system.

The system works in conjunction with thin wooden boards to stop the board from bowing once installed.

Overview

- Compatible with systems LIBRO MAXI (PS11), PIANO (PS40), VOLO (PS48) and AGILE (PS60)
- For use with wooden board
- Door straightening kit for 1 door
- 35mm cup drilling
- Cut to size
- Allows for Internal and external adjustment of the door
- Material: Zamac
- Comes with a plastic cover
- Finish: Grey
- For 16-18mm board
- Height: 2220mm

DOOR STRAIGHTENER



CINETTO WOODEN DOOR STRAIGHTENER.

The Cinetto Door Straightener System allows for creativity and flexibility in customising your sliding door system. The system works in conjunction with thin wooden boards to stop the board from bowing once installed.

Features:

- For 16-18mm board
- For use with wooden board
- Door straightening kit for 1 door
- 35mm cup drilling
- Cut to size
- Allows for Internal and external adjustment of the door
- Comes with a plastic cover
- Material: Zamac
- Finish: Grey

TECHNICAL DETAILS:

CODE	LENGTH
CBR04DS	2220mm

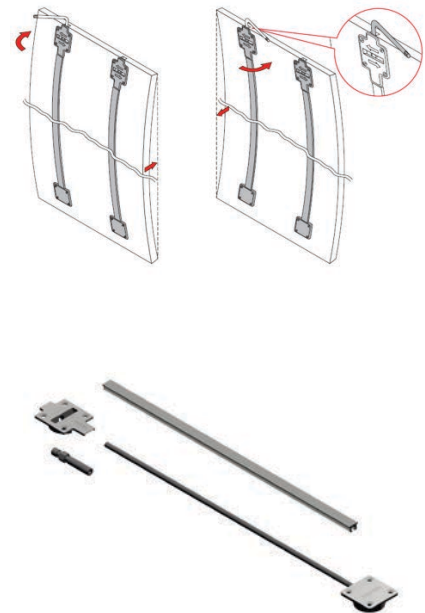

HANDLE PROFILE

CINETTO ACCESSORIES

Available for the Cinetto Sliding Systems is a range of Aluminium profile handles. These high quality Aluminium profiles come in a variety of applications.

Overview

- Suitable for wooden doors
- Cut to customised heights
- To suit Piano (PS40), Volo (PS48) & Agile (PS60)

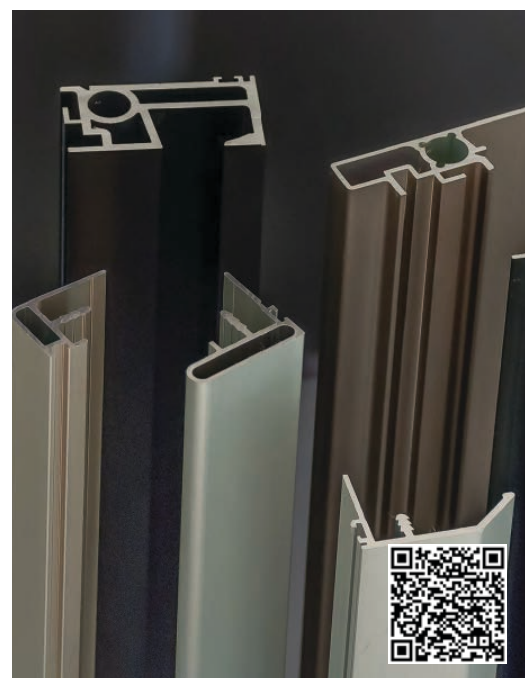

RANGE SELECTION GUIDE

FUNCTION	BI-FOLDING				BOTTOM ROLLING			
PRODUCT NAME	PS11	PS23	PS23	PS23	PS03	PS03	PS22	PS60
	LIBRO MAXI	LIBRO (w bottom track)	LIBRO (w/o bottom track)	LIBRO mini	BASE (Glass)	BASE (Timber)	IDEA	AGILE
VISUAL DESCRIPTION								
FUNCTION	Sliding Bi-Fold System Not fixed to the end of the cabinet	Bi-Fold System Fixed to the cabinet end	Bi-Fold System Fixed to the cabinet end	Bi-Fold System Fixed to the cabinet end	Sliding System for Internal Doors	Sliding System for Internal Doors	One Way Sliding System for Frontally Applied Doors	Bottom Rolling Sliding System for Single Sided Doors
MAX DOOR HEIGHT	3000mm	3000mm	2400mm	2100mm	1200mm	1200mm	1200mm	3000mm
DOOR THICKNESS	Min 16 & 18mm with Vertical Adjustment	16mm-35mm	16mm-35mm	16mm-35mm	5mm	16mm-50mm	16mm	18mm
DOOR WIDTH	600-1000mm per leaf	400-1200mm per leaf	400-900mm per leaf	400-900mm per leaf	400mm-1200mm	400mm-1200mm	Any - must be wider than the height	Min 500-790mm Minimum dependent on door quantity & soft close
WEIGHT CAPACITY	40kg per double door set	50kg per double door set	50kg per double door set	25kg per double door set	20kg per door	20kg per door	20kg per door	60kg per door
MAX DOOR/ LEAF QTY	5 leaves per track	1 leaf per side	1 leaf per side	1 leaf per side	-	-	-	4 doors
SOFT CLOSE	No	Yes Using soft close hinges	Yes Using soft close hinges	Yes Using soft close hinges	No	Yes	Yes	Yes
TRACK LENGTH	3050mm	2m or 3050mm	2m or 3050mm	2m or 3050mm	3050mm	3050mm	3050mm	3050mm
<i>B-moved</i> COMPATIBLE	No	No	No	No	No	No	No	No

BI-FOLDING



BOTTOM ROLLING



FUNCTION	TOP HUNG					RETRACTING
PRODUCT NAME	PS06	PS08	PS40	PS48	PS48	PS66
	VELOCE	INVISIBLE	PIANO	VOLO Soft close	VOLO No soft close	MAGICO
VISUAL DESCRIPTION						
FUNCTION	Sliding System for Hanging Doors	One Way Sliding System with Invisible Tracks	Coplanar Door System (Flush Doors)	Sliding System for Overlapping Doors	Sliding System for Overlapping Doors	Sliding System for Retractable Doors
DOOR HEIGHTS	2500mm	2800mm	3000mm	3000mm	3000mm	2400mm-2700mm
DOOR THICKNESS	18mm-50mm	-	16mm-43mm 55mm including handles	18mm-32mm	18mm-32mm	25mm-40mm
DOOR WIDTH	500mm-1400mm	450mm-1400mm	890mm-1800mm	400mm (1 way soft close) 760mm (2 way soft close)	400mm	600mm-1000mm
WEIGHT CAPACITY	50kg per door	60kg per door	45kg-60kg per door depending on configuration	80kg per door	80kg per door	50kg per door
MAX DOOR QTY	Up to 3 per unit	-	Up to 3	Up to 4	Up to 4	1
SOFT CLOSE	Yes	Yes	Yes	Yes	Yes	Yes
TRACK LENGTH	3050mm	3050mm	2m or 4m	2m or 4m	2m or 4m	-
B-moved COMPATIBLE	No	No	Yes	Yes	Yes	No

TOP HUNG



RE-TRACTING





Instagram:
@wilsonandbradley



Facebook:
Wilson & Bradley



YouTube:
@wilsonandbradley



TikTok:
@wilsonandbradley



Pinterest
@wilsonandbradley



Houzz
Wilson & Bradley



ArchiPro:
@wilsonandbradley

Melbourne

94 Bell Street
Preston VIC 3072

Sydney

Unit 4, 3 Basalt Road
Greystanes NSW 2145

Perth

19 Christable Way
Landsdale WA 6065

Brisbane

Building 4.1, Logrunner Place
Willawong QLD 4110

Adelaide

9/20 Cheltenham Parade
Woodville SA 5011

Tasmania

Ph: 1800 633 507

Contact us for more information on any of our products, or visit our website for instructional videos, promotions and manuals.

Wilson & Bradley Pty Ltd

Support

1800 633 507
sales@wilbrad.com.au

Online Store

wilbrad.com.au

wilson
&bradley

Scan the QR code to
view our interactive
brochures online.

