

SIGE KITCHEN STORAGE SOLUTIONS

Premium home storage products



wilson
&bradley

CONTENTS



4. Overview



5. Materia



11. Pro Line



20. Infinity Plus



30. Valore



39. Laundry Baskets

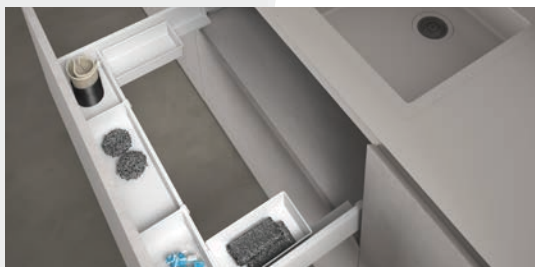

44. Under Sink

SIGE KITCHEN STORAGE SOLUTIONS

WILSON & BRADLEY

In this brochure you will find the latest range of SIGE kitchen storage solutions available at Wilson & Bradley.

Available in a range of styles, and with four ranges to choose from, the SIGE range of kitchen storage solutions are designed to provide years of reliable service throughout the home.





Code: SM4CP90R

SIGE



Established in Italy, SIGE has been designing, developing and supplying manufacturers with wire ware for the kitchen and bathroom industry since 1969.

Distributed by Wilson & Bradley, SIGE storage solutions are easy to install and are designed to provide years of reliable service throughout the home.

With a strong focus on ensuring the best quality, the SIGE wire ware range builds further upon Wilson & Bradley's brand by offering a range of innovative storage benefits, premium design finishes and the latest soft close technology.

SIGE offers 4 different storage solutions for your home:

- SIGE Materia
- SIGE Pro Line
- SIGE Infinity Plus
- SIGE Valore

Key features:

- Easy to install and assemble.
- Perfect for maximising storage.
- Designed to assist with the organisation of your kitchen.
- Available in both left-hand and right-hand applications.
- Designed to suit a variety of cabinet spaces.
- Life-cycle tested to ensure ongoing dependable quality.



Code: SMPD450

MATERIA



The SIGE Materia range combines superb functionality and technology with a beautiful minimalist design. With clean Orion Grey surrounds and Silver Grey bases, the Materia range offers a premium modern design as well as top of the range quality.

With a strong focus on ensuring the best quality, the SIGE Materia range integrates soft-close technology that adds ease and functionality when in use and is life cycle tested to

ensure longevity and consistent premium performance. The Materia range offers a variety of storage solutions including pull-out pantries, bottle racks, corner units and kidney shelves to complement modern kitchen spaces.

Key features:

- Available in orion grey finish with silver grey wooden bases.
- Designed to assist with the organisation of your kitchen.
- Full extension, soft-close runners.
- Available in both left-hand and right-hand applications.

- Suits a variety of cabinet spaces.
- Life-cycle tested to ensure ongoing dependable quality.
- Great visibility and designed for minimal cleaning.
- Full extension, soft-close runners.
- Easy to install and assemble.
- Can be retrofitted.

Visit our website to find out more about the SIGE Materia range www.wilbrad.com.au or call us on **1800 633 507**.

PULL OUTS

SIDE MOUNT BOTTLE RACK (LEFT HAND MOUNTED)

- Perfect to organise non-perishables or for use as a bottle rack.
- For use with 150mm external cabinet width
- Soft-close full extension runners
- Mounts to door with supplied brackets
- Includes spacers
- Includes two orion grey baskets with silver grey base
- Weight capacity: 12kg



Technical Details

CODE	▶◻◀	WIDTH	DEPTH	HEIGHT
SMBRS150	150mm	110mm	500mm	520mm



BOTTOM MOUNT PULL OUT BASKET

- Available in two sizes
- Soft-close full extension runners
- Mounts to door with supplied brackets
- Includes two orion grey baskets with silver grey base
- Weight capacity: 30kg



Technical Details

CODE	▶◻◀	WIDTH	DEPTH	HEIGHT
SMBRB300	300mm	260-268mm	500mm	520mm
SMBRB450	450mm	410-418mm	500mm	520mm



PULL OUTS

PANTRY DRAWER

- Available in three sizes
- Soft-close, full extension runners
- Allows for customisation - Choose how many drawers you require
- Pull out drawer perfect for use in pantry
- Orion grey with silver grey base
- Weight Capacity: 30kg

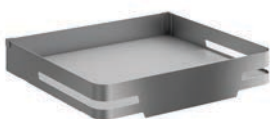

Technical Details

CODE	▶◻◀	WIDTH	DEPTH	HEIGHT
SMPD450	450mm	450mm	500mm	100mm
SMPD600	600mm	560-568mm	500mm	100mm
SMPD900	900mm	860-868mm	500mm	100mm



PULL OUT ORGANISER

- To suit 300mm carcass
- Multi-purpose pull out basket in Orion Grey with Melamine base
- Features full extension SIGE soft close runners
- Easy to install
- Weight capacity: 30kg



Technical Details

CODE	▶◻◀	WIDTH	DEPTH	HEIGHT
SMPOA300	300mm	260mm	495mm	574mm



PANTRY UNITS

PULL OUT PANTRY

- Includes five baskets
- For use in pantry with pantry frame and runner kit
- Five sizes available
- Orion grey with silver grey base
- Weight capacity: 120kg



Technical Details

CODE	▶◻◀	WIDTH	DEPTH	HEIGHT
SMPB300	300mm	230mm	440mm	90mm
SMPB400	400mm	330mm	440mm	90mm
SMPB450	450mm	380mm	440mm	90mm
SMPB500	500mm	430mm	440mm	90mm
SMPB600	600mm	530mm	440mm	90mm



PANTRY RUNNER KIT

- Includes full extension slides and door brackets
- Full extension soft-close runners
- Orion grey finish

Technical Details

CODE	▶◻◀	WEIGHT CAPACITY
SWPRS300G	300mm	120kg
SWPRS400G	400mm	120kg
SWPRS450G	450mm	120kg
SWPRS500G	500mm	120kg
SWPRS600G	600mm	120kg



PANTRY FRAME

- Adjustable height
- Baskets and runner kit must be purchased separately
- Weight capacity: 120kg

Technical Details

CODE	DEPTH	HEIGHT	FINISH
SWPFRG	505mm	1880-2180mm	Orion Grey

PULL OUT PANTRY KITS

- Kit comes complete with five baskets, pantry frame and soft close runner and bracket set

CODE	▶◻◀	WEIGHT
SMP3	300mm	120kg
SMP4	400mm	120kg
SMP45	450mm	120kg
SMP5	500mm	120kg
SMP6	600mm	120kg

PANTRY UNITS

DOOR FOLLOW PANTRY UNITS

- For use with SIGE Materia Door Follow pantry
- Orion grey finish with silver grey base
- Includes five baskets
- Weight capacity: 80kg
- Minimum height: 1880mm



Technical Details

CODE	▶◻◀	WIDTH	DEPTH	HEIGHT
SMDFPB300	300mm	260mm	500mm	100mm
SMDFPB400	400mm	360mm	500mm	100mm
SMDFPB450	450mm	410mm	500mm	100mm
SMDFPB500	500mm	460mm	500mm	100mm
SMDFPB600	600mm	560mm	500mm	100mm



DOOR FOLLOW PANTRY FRAME AND BRACKET SET

- For use with SIGE Materia door follow pantry
- Baskets and runner kit must be purchased separately
- Weight capacity: 60kg



DOOR FOLLOW PANTRY SLIDES

- Durable components
- Simple to install
- Allows for easy access

Code: **SMDFPS**

Technical Details

CODE	▶◻◀
SMDFPF30	300mm
SMDFPF40	400mm
SMDFPF45	450mm
SMDFPF50	500mm
SMDFPF60	600mm

SIGE MATERIA DOOR FOLLOW PANTRY KITS

- Kit comes complete with five baskets, pantry frame and pantry slides

CODE	▶◻◀	WEIGHT
SMDFP3	300mm	60kg
SMDFP4	400mm	60kg
SMDFP45	500mm	60kg
SMDFP5	400mm	60kg
SMDFP6	500mm	60kg

CORNER UNITS

CORNER PULL OUT

- Includes two door mounted baskets and two internal baskets
- Available in left-hand and right-hand application
- Orion grey finish with silver grey base
- Soft-open and close action
- Weight capacity (Internal): 20kg
- Weight capacity (Door Mounted): 15kg

Technical Details

CODE	APPLICATION	▶◻◀	WIDTH	DEPTH	HEIGHT
SM4CP90L	Left Hand	900mm	860mm	505mm	600mm
SM4CP90R	Right Hand	900mm	860mm	505mm	600mm



KIDNEY SHELVES

- Designed to fit onto existing shelves
- Available in left-hand and right-hand application
- Includes two shelves
- Orion grey finish with silver grey base
- Weight capacity: 20kg per shelf

Technical Details

CODE	APPLICATION	▶◻◀	WIDTH	DEPTH
SMKS945L	Left Hand	900mm	450mm	500mm
SMKS945R	Right Hand	900mm	450mm	500mm



SIGE SOFT CLOSE KIT FOR KIDNEY SHELF

- Suits two shelves

Code: **SMKSSCK**





Code: SP4CP90R

PRO LINE



Wilson & Bradley are proud to introduce the SIGE Pro Line range to our range of quality wire ware solutions.

This new concept defines all kitchens clear lines in a more ergonomic way.

SIGE Pro Line incorporates painted metal surrounds, creating a good balance between minimalism and design.

Key features:

- Painted metal surrounds
- White finish
- To suit Blum MOVENTO runners
- Comes with white anti-slip matting
- Easy to assemble and secure in place
- Stable and rapid sliding motion
- Strong and sturdy construction
- Range includes pull outs, corner units and pantry units
- Designed to assist with the organisation of your kitchen.
- Available in both left-hand and right-hand applications.
- Designed to suit a variety of cabinet spaces.
- Life-cycle tested to ensure ongoing dependable quality.
- Can be retrofitted.

PULL OUTS

SIDE MOUNT SOFT CLOSE BOTTLE RACK 150MM & 200MM

- To suit Blum 500mm MOVENTO runners (sold separately)
- Left and right-hand mounting
- White painted metal finish with melamine base
- Comes with white anti-slip matting
- Easy to install
- Available in 2 sizes
- Perfect to organise non-perishables or for use as a bottle rack.
- Mounts to door with supplied brackets

Technical Details

CODE	▶◻◀	WIDTH	DEPTH	HEIGHT
SPBRS150	150mm	110-118mm	500mm	520mm
SPBRS200	200mm	160-168mm	500mm	520mm



SIDE MOUNT SOFT CLOSE BOTTLE RACK 300MM

- To suit 300mm carcass
- To suit Blum 500mm MOVENTO runners (sold separately)
- Left and right-hand mounting
- White painted metal finish with melamine base
- Easy to install
- Mounts to door with supplied brackets

Technical Details

CODE	▶◻◀	WIDTH	DEPTH	HEIGHT
SPBRB300	300mm	262-268mm	500mm	520mm



PULL OUT KITS

SIDE MOUNT SOFT CLOSE BOTTLE RACK 150MM & 200MM

Includes bottle rack and 40kg Blum MOVENTO runners.



Kit Details

CODE	▶◻◀	WIDTH	DEPTH	HEIGHT
SPBRS150K	150mm	110-118mm	500mm	520mm
SPBRS200K	200mm	160-168mm	500mm	520mm
SPBRB300K	300mm	262-268mm	500mm	520mm



PULL OUTS

SIDE MOUNT SOFT CLOSE TRIPLE BOTTLE RACK

- To suit 150mm carcass
- To suit Blum 500mm MOVENTO runners (Runners sold separately)
- Left and right-hand mounting
- White painted metal finish with melamine base
- Comes with white anti-slip matting
- Easy to install
- Perfect to organise non-perishables or for use as a bottle rack.
- Mounts to door with supplied brackets

Technical Details

CODE	▶◻◀	WIDTH	DEPTH	HEIGHT
SPTBRS150	150mm	110-118mm	500mm	850mm



TRIPLE BOTTLE RACK KIT

Includes SIGE Pro Line Triple Bottle Rack and 40kg Blum MOVENTO runners.

Technical Details

CODE	▶◻◀	WIDTH	DEPTH	HEIGHT
SPTBRS150K	150mm	110-118mm	500mm	850mm



CORNER UNITS

CORNER PULL-OUT

- To suit 900mm carcass.
- Available in left and right-hand application
- Includes 2 internal and 2 door mounted baskets
- Soft opening and soft closing action
- White painted metal finish
- Includes corner mechanism
- Easy to install
- Weight capacity (internal): 25kg
- Weight capacity (external): 25kg

Technical Details

CODE	▶◻◀	WIDTH	DEPTH	HEIGHT	MOUNT
SP4CP90R	900mm	860-868mm	505mm	600mm	Right Hand
SP4CP90L	900mm	860-868mm	505mm	600mm	Left Hand



KIDNEY SHELF

- To suit 900mm carcass.
- Available in left and right-hand application
- Includes 2 shelves
- White painted metal finish with melamine base
- Easy to install
- Weight capacity: 25kg per shelf
- Also available in kit form (SPKU900L & SPKU900R) which includes support pole and soft close

Technical Details

CODE	▶◻◀	WIDTH	DEPTH	HEIGHT	MOUNT
SPKS900R	900mm	450mm	490mm	160mm	Right Hand
SPKS900L	900mm	450mm	490mm	160mm	Left Hand



KIDNEY SHELF KITS

Includes SIGE Pro Line Kidney Unit, support pole and soft close kit.

Technical Details

CODE	▶◻◀	WIDTH	DEPTH	HEIGHT	MOUNT
SPKU900R	900mm	450mm	470mm	600mm	Right Hand
SPKU900L	900mm	450mm	470mm	600mm	Left Hand



SIGE KIDNEY UNIT SUPPORT POLE

- Colour: White and Aluminium
- Available in both left and right-hand application
- To be used in conjunction with SMKSSCK, SWKS900L, SWKS900R, SPKU900L and SPKU900R.

Technical Details

CODE	MOUNT
SPKUSPL	Left Hand
SPKUSPR	Right Hand



SIGE SOFT CLOSE KIT FOR KIDNEY SHELF

- Suits two shelves

Code: **SMKSSCK**





CORNER UNITS

3/4 CAROUSEL SHELF

- To suit 900mm carcass
- Rotating system with bottom fixed plate
- Includes two carousel shelves
- Designed to suit corner cabinets
- White painted metal finish with melamine base
- Easy to install



Technical Details

CODE	WIDTH	DEPTH	HEIGHT	WEIGHT CAPACITY
SPCARS900	850mm	500mm	110mm	40kg

PANTRY UNITS

COMPONENTS FOR PULL OUT PANTRY

- Available in four sizes: 300mm, 400mm, 500mm and 600mm
- Code includes five baskets
- White painted metal finish



Technical Details

CODE	▶◻◀	WIDTH	DEPTH	HEIGHT
SPPB300	300mm	230mm	475mm	75mm
SPPB400	400mm	330mm	475mm	75mm
SPPB500	500mm	430mm	475mm	75mm
SPPB600	600mm	530mm	475mm	75mm



PANTRY FRAME

- Adjustable height
- Baskets and runner kit must be purchased separately
- Colour: White
- Available in two sizes: Medium and Large

Technical Details

CODE	SIZE	DEPTH	WEIGHT CAPACITY
SWPFRMW	Medium	505mm	1615 - 1915mm
SWPFRW	Large	505mm	1880 - 2180mm

PANTRY RUNNER KIT

- Includes full extension slides and door brackets
- Full extension soft close runners
- Colour: White
- Available in four sizes: 300mm, 400mm, 500mm and 600mm



Technical Details

CODE	▶◻◀	WEIGHT CAPACITY
SWPRS300W	300mm	120kg
SWPRS400W	400mm	120kg
SWPRS500W	500mm	120kg
SWPRS600W	600mm	120kg

PANTRY UNITS

PULL OUT PANTRY KITS

Kits come complete with five baskets, pantry frame and soft close runner set

Large Pantry Frame Kits

CODE	▶◻◀	WIDTH	DEPTH	HEIGHT
SPPP3C1	300mm	250mm	505mm	1880 - 2180mm
SPPP4C1	400mm	350mm	505mm	1880 - 2180mm
SPPP5C1	500mm	450mm	505mm	1880 - 2180mm
SPPP6C1	600mm	550mm	505mm	1880 - 2180mm

Medium Pantry Frame Kits

CODE	▶◻◀	WIDTH	DEPTH	HEIGHT
SPPP3C2	300mm	250mm	505mm	1615 - 1915mm
SPPP4C2	400mm	350mm	505mm	1615 - 1915mm
SPPP5C2	500mm	450mm	505mm	1615 - 1915mm
SPPP6C2	600mm	550mm	505mm	1615 - 1915mm



PULL OUT PANTRY UNIT

- To suit 200mm carcass
- Full Extension SIGE Slides with Soft Close
- Complete with 5 baskets and door brackets
- White Painted Metal Finish with Melamine Base
- Comes with White Anti Slip Matting
- Easy to install
- Weight Capacity: 50kg

Technical Details

CODE	▶◻◀	WIDTH	DEPTH	HEIGHT
SPPP200	200mm	150mm	505mm	1880 - 2180mm





Code: SW4CP900L

INFINITY PLUS



Boasting a unique modern design, the SIGE Infinity Plus range aims to enhance and redefine the kitchen which surrounds it.

Achieving functionality on a number of levels, each product is easy to install and operate, making time spent in the kitchen a more efficient and pleasant experience.

SIGE uses only high-quality materials, such as the flat wire and its chromed finishes and teams this with clean solid bases to create a distinct finish.

Offering a variety of storage solutions including pull out pantries, bottle racks, corner units and kidney shelves, SIGE storage solutions complement the kitchen space.

Key features:

- Designed to take advantage and makes full use of every available space the kitchen has to offer.
- Designed to assist with the organisation of your kitchen.
- Available in both left-hand and right-hand applications.

- Designed to suit a variety of cabinet spaces.
- Life-cycle tested to ensure ongoing dependable quality.
- Modern and unique design to enhance and enrich any kitchen's décor.
- Easy to install and assemble.
- High quality chrome surrounds with solid bases on baskets.

Visit our website to find out more about the SIGE Infinity Plus range www.wilbrad.com.au or call us on **1800 633 507**.

PULL OUTS

SIDE MOUNT SOFT CLOSE BOTTLE RACK (LEFT HAND MOUNTED)

- Perfect to organise non-perishables or for use as a bottle rack.
- For use with 150mm external cabinet width.
- Soft-close full extension runners.
- Mounts to door with supplied brackets.
- Includes two chrome baskets with solid bases.
- Includes full extension runners and spacers.
- Chrome finish
- Weight capacity: 12kg

Technical Details

CODE	▶◻◀	WIDTH	DEPTH	HEIGHT
SWBRS150	150mm	110mm	500mm	520mm



SIDE MOUNT SOFT CLOSE TOWEL RAIL (LEFT HAND MOUNTED)

- Includes towel rail and basket
- Soft-close runners
- Smooth opening action
- Chrome finish
- Weight capacity: 8kg

Technical Details

CODE	▶◻◀	WIDTH	DEPTH	HEIGHT
SWTRS150	150mm	110mm	500mm	620mm



BOTTOM MOUNT SOFT CLOSE BOTTLE RACK

- Available in two sizes
- Soft-close full extension runners
- Mounts to door with supplied brackets
- Includes two chrome baskets with solid bases
- Chrome finish
- Weight capacity: 30kg

Technical Details

CODE	▶◻◀	WIDTH	DEPTH	HEIGHT
SWBRB300	300mm	260-268mm	500mm	520mm
SWBRB450	450mm	410-418mm	500mm	520mm



PANTRY UNITS

PANTRY DRAWERS

- Available in two sizes
- Allows for customisation - Choose how many drawers you require
- Pull out drawer perfect for use in pantry
- Soft-close, full extension runners
- Chrome basket with solid base
- Weight capacity: 30kg

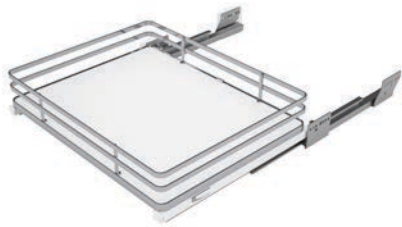

Technical Details

CODE	▶◻◀	WIDTH	DEPTH	HEIGHT
SWPD450	450mm	450mm	500mm	90mm
SWPD600	600mm	560 - 568mm	500mm	90mm



PANTRY UNITS

PULL OUT PANTRY

- Includes five baskets
- For use with Pantry frame and runner kit
- Four sizes available
- Chrome finish

CODE	▶◻◀	WIDTH	DEPTH	HEIGHT
SWPB300	300mm	230mm	440mm	120mm
SMPB400	400mm	330mm	440mm	120mm
SMPB500	500mm	430mm	440mm	120mm
SMPB600	600mm	530mm	440mm	120mm



PANTRY FRAME

- Adjustable height
- Baskets and runner kit must be purchased separately
- Weight capacity: 120kg
- Chrome finish

CODE	DEPTH	HEIGHT
SWPFR	505mm	1880-2180mm
SWPFRM	505mm	1615-1915mm

PANTRY RUNNER KIT

- Includes full extension slides and door brackets
- Full extension soft-close runners
- Chrome finish

CODE	▶◻◀	WEIGHT CAPACITY
SWPRS300	300mm	120kg
SWPRS400	400mm	120kg
SWPRS500	500mm	120kg
SWPRS600	600mm	120kg

PULL OUT PANTRY KITS

- Kits include five baskets, pantry frame and soft close runner and bracket set
- Weight capacity: 120kg

Large Pantry Frame Kits

CODE	▶◻◀	WIDTH	DEPTH	HEIGHT
SPP3	300mm	250mm	505mm	1880-2180mm
SPP4	400mm	350mm	505mm	1880-2180mm
SPP5	500mm	450mm	505mm	1880-2180mm
SPP6	600mm	550mm	505mm	1880-2180mm

Medium Pantry Frame Kits

CODE	▶◻◀	WIDTH	DEPTH	HEIGHT
SPP3M	300mm	250mm	505mm	1615-1915mm
SPP4M	400mm	350mm	505mm	1615-1915mm
SPP5M	500mm	450mm	505mm	1615-1915mm
SPP6M	600mm	550mm	505mm	1615-1915mm

PANTRY UNITS

DOOR FOLLOW PANTRY

- Pantry unit follows door as it is opened
- System comes complete with six baskets, runners and brackets
- Features soft-close full extension runners
- Includes six chrome baskets with solid base
- Weight capacity: 60kg



Technical Details

CODE	▶◻◀	WIDTH	DEPTH	HEIGHT
SWPDF600	600mm	560mm	500mm	1950 - 2166mm



PULL OUT PANTRY UNIT

- System comes complete with five baskets, runners and brackets.
- Features soft-close full extension runners.
- Mounts to the door with supplied brackets.
- Includes five chrome baskets with solid base.
- Weight capacity: 80kg



Technical Details

CODE	▶◻◀	WIDTH	DEPTH	HEIGHT
SWPP200	200mm	150mm	505mm	1880 - 2180mm



PANTRY UNITS

TWIN PANTRY

- Swing out tandem unit
- Available in two sizes
- Includes six door mount and six internal baskets
- Features soft-close runners
- Smooth opening action
- Chrome finish
- Weight capacity: 80kg



Technical Details

CODE	▶◻◀	WIDTH	DEPTH	HEIGHT
SWTPOD450	450mm	410mm	470mm	1800mm
SWTPOD600	600mm	560mm	470mm	1800mm



SMALL TWIN PANTRY

- Suitable for short pantry applications
- Includes four door mount and four internal baskets
- Features soft-close runners
- Smooth opening action
- Chrome baskets with solid base
- Weight capacity: 50kg



Technical Details

CODE	▶◻◀	WIDTH	DEPTH	HEIGHT
SWSTPO450	450mm	410mm	470mm	1215mm
SWSTPO500	500mm	460mm	470mm	1215mm
SWSTPO600	600mm	560mm	470mm	1215mm





PANTRY UNITS

ROTATING PANTRY

- Unit rotates as door opens
- System comes complete with five baskets, runners and brackets.
- Mounts to door front with brackets provided
- Features soft-close full extension runners
- Smooth opening action
- Chrome finish
- Weight capacity: 120kg

Technical Details

CODE	▶◻◀	WIDTH	DEPTH	HEIGHT
SWRP400	400mm	300mm	505mm	1950 - 2166mm



CORNER UNITS

3/4 CAROUSEL SHELF

- Includes shelf only
- Chrome shelf with solid base
- Can be retrofitted to existing shelves
- Sold as a single carousel shelf
- Weight capacity: 30kg per shelf



Technical Details

CODE	▶◻◀	WIDTH	DEPTH	HEIGHT
SWCARS800	800mm	700mm	700mm	110mm
SWCARS900	900mm	800mm	800mm	110mm



KIDNEY SHELVES

- Designed to be fit onto existing shelves
- Available in left-hand and right-hand application
- Includes two shelves
- Chrome finish. White melamine base with chrome surround.
- Weight Capacity: 20kg per shelf.

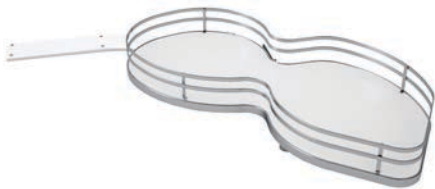

Technical Details

CODE	APPLICATION	▶◻◀	WIDTH	DEPTH	HEIGHT
SWKS900L	Left Hand	900mm	414mm	500mm	650 - 750mm
SWKS900R	Right Hand	900mm	414mm	500mm	650 - 750mm



CORNER UNITS

HALF MOON CORNER UNIT

- Consists of two rotating shelves
- Chrome finish: White melamine base with chrome surround
- Weight capacity: 20kg



Technical Details

CODE	▶◻◀	WIDTH	DEPTH	HEIGHT
SWHMCU	800mm	760mm	390mm	510mm



CORNER PULL OUT

- Includes two door mounted baskets and two internal baskets
- Available in left-hand and right-hand application
- Soft-open and close action
- Chrome finish: White melamine base with chrome surround.
- Weight capacity (Internal): 20kg
- Weight capacity (Door Mounted): 15kg

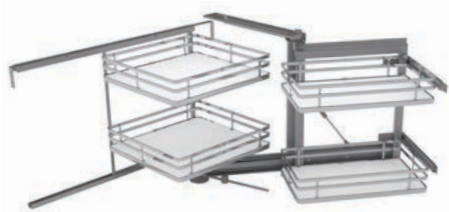

Technical Details

CODE	APPLICATION	▶◻◀	WIDTH	DEPTH	HEIGHT
SW4CP900L	Left Hand	900mm	860mm	505mm	600 - 850mm
SW4CP900R	Right Hand	900mm	860mm	505mm	600 - 850mm



CORNER UNITS

SIGE KIDNEY UNIT SUPPORT POLE

- Colour: White and Aluminium
- Available in both left and right-hand application
- To be used in conjunction with SMKSSCK, SWKS900L, SWKS900R, SPKU900L and SPKU900R.

Technical Details

CODE	MOUNT
SPKUSPL	Left Hand
SPKUSPR	Right Hand



SIGE SOFT CLOSE KIT FOR KIDNEY SHELF

- Suits two shelves

Code: **SMKSSCK**





Code: SVPOB450

VALORE



The SIGE Valore range features a new elegant contemporary look and includes a variety of storage solutions including pull-outs, corner units and pantries designed to make the most of available heights and spaces.

Key features:

- Chrome finish
- Easy to assemble and secure in place
- Stable and rapid sliding motion
- Strong and sturdy construction

Why SIGE?

- Made in Italy
- Easy to install
- Life-cycle tested to ensure ongoing and dependable quality

View the entire SIGE Valore range and find out more on our website: www.wilbrad.com.au or call **1800 633 507**.

PULL OUTS

JOLLY BASKET (150MM & 200MM)

- Available for use in 150mm and 200mm external cabinet width
- Features full extension SIGE slides with soft close runners
- Easy to install
- Chrome finish
- Includes two baskets
- Weight capacity: 10kg

Technical Details

CODE	▶◻◀	WIDTH	DEPTH	HEIGHT	MOUNT
SVBSL150	150mm	110mm	450mm	520mm	Left hand
SVBSL200	200mm	160mm	500mm	520mm	Left hand



JOLLY BASKET (300MM)

- Available for use in 300mm external cabinet width
- Features full extension SIGE slides with soft close runners
- Easy to install
- Chrome finish
- Includes two baskets
- Weight capacity: 30kg

Technical Details

CODE	▶◻◀	WIDTH	DEPTH	HEIGHT	MOUNT
SVBSL300	300mm	260mm	500mm	520mm	Bottom Fixed





PULL OUT ORGANISER

SIGE VALORE PULL OUT ORGANISER

- To suit 300mm carcass
- Multi-purpose pull out basket in white with metal surrounds
- Features full extension SIGE soft close runners
- Easy to install
- Weight capacity: 30kg

Technical Details

CODE	▶◻◀	WIDTH	DEPTH	HEIGHT
SVPOA300	300mm	260mm	495mm	574mm

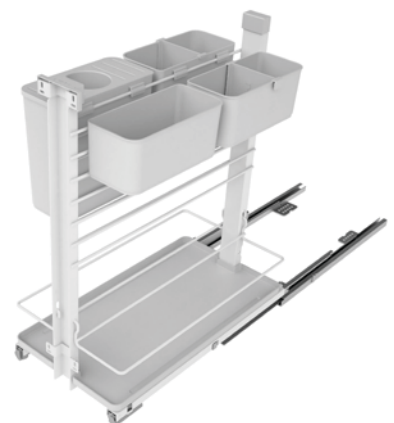



UNDER SINK BASKETS

REVERSIBLE BASKET

- For use in 300mm and 450mm external cabinet width
- Features full extension SIGE slides with soft close runners
- Complete with plastic base tray & bottle separators
- Easy to install
- Chrome finish
- Weight capacity: 30kg

Technical Details

CODE	▶◻◀	WIDTH	DEPTH	HEIGHT	MOUNT
SVRBS300	300mm	230mm	500mm	440mm	Bottom Fixed
SVRBS450	450mm	380mm	500mm	440mm	Bottom Fixed



CORNER UNITS

HALF MOON BASKET

- To suit 900mm cabinet
- Includes two shelves
- Door or manual opening
- Ideal for corner base unit
- Easy to install
- Chrome finish
- Weight capacity: 15kg

Components: Two half moon baskets, fixing bracket & connection bracket

Technical Details

CODE	▶◻◀	WIDTH	DEPTH	HEIGHT
SVHMB900	900mm	760mm	390mm	100mm

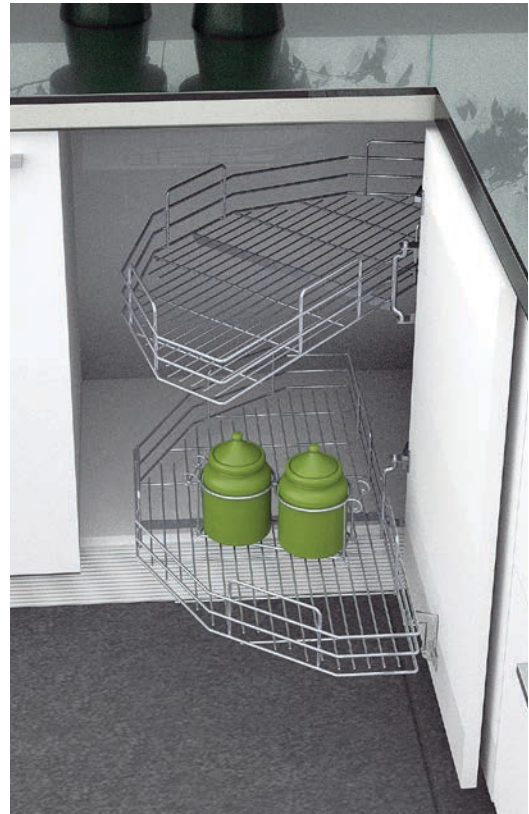

CORNER PULL-OUT BASKET

- To suit 900mm cabinet
- Includes four baskets: two door mounted and two internal baskets
- Available in left and right-hand application
- Weight capacity: 35kg

Components: Four baskets, basket frames, brackets, covers, joint, post connection, linking arm, hooks, mounts & bushes

Technical Details

CODE	APPLICATION	▶◻◀	WIDTH	DEPTH	HEIGHT
SVPC4900L	Left hand	900mm	860 - 1000mm	470 - 505mm	600mm
SVPC4900R	Right hand	900mm	860 - 1000mm	470 - 505mm	600mm





SIGE VALORE ¾ CAROUSEL SHELF

- To suit 900mm carcass
- Rotating corner carousel system with 2 shelves
- Chrome finish
- Easy to install
- Weight capacity: 30kg



Technical Details

CODE	▶◻◀	DEPTH	HEIGHT
SVRCB90	900mm	800mm	700mm - 750mm



PANTRY UNITS

PULL-OUT PANTRY

- To suit 200mm cabinet
- System comes complete with five pull-out baskets, runners and brackets
- Features full extension SIGE slides with soft close technology
- Mounts to door with supplied brackets
- Chrome finish
- Weight capacity: 80kg

Components: Five baskets, top and bottom runners & brackets

Technical Details

CODE	▶◻◀	WIDTH	DEPTH	HEIGHT
SVPOT200	200mm	150mm	500mm	1880 - 2180mm



PANTRY UNITS

PANTRY DRAWER

- Available for use with 450mm or 600mm external cabinet width
- Features full extension SIGE slides with soft close runners
- Easy to install
- Chrome finish
- Weight capacity: 30kg

Components: Basket, soft close runners, cover kit, spacers & cap

Technical Details

CODE	▶◻◀	WIDTH	DEPTH	HEIGHT
SVPOB450	450mm	410mm	500mm	180mm
SVPOB600	600mm	560mm	500mm	180mm



PULL-OUT PANTRY KITS

Components: Five baskets, soft close runners, brackets & frame

Large Pantry Frame Kits

CODE	▶◻◀	WIDTH	DEPTH	HEIGHT
SVPP3C	300mm	230mm	505mm	1880 - 2180mm
SVPP4C	400mm	230mm	505mm	1880 - 2180mm
SVPP5C	500mm	230mm	505mm	1880 - 2180mm
SVPP6C	600mm	230mm	505mm	1880 - 2180mm

Medium Pantry Frame Kits

CODE	▶◻◀	WIDTH	DEPTH	HEIGHT
SVPP3M	300mm	250mm	505mm	1615 - 1915mm
SVPP4M	300mm	250mm	505mm	1615 - 1915mm
SVPP5M	300mm	250mm	505mm	1615 - 1915mm
SVPP6M	300mm	250mm	505mm	1615 - 1915mm



COMPONENTS FOR PULL-OUT PANTRY

PULL-OUT BASKETS

- Includes five wire bottom baskets
- For use with pantry frame, runner and bracket set
- Available in four sizes: 300mm, 400mm, 500mm and 600mm
- Chrome finish

Technical Details

CODE	▶◻◀	WIDTH	DEPTH	HEIGHT
SVB5300	300mm	230mm	440mm	120mm
SVB5400	400mm	330mm	440mm	120mm
SVB5500	500mm	430mm	440mm	120mm
SVB5600	600mm	530mm	440mm	120mm



PANTRY RUNNER KIT

- Includes full extension slides and door brackets
- Full extension soft close runners
- Chrome finish

Technical Details

CODE	▶◻◀	WEIGHT CAPACITY
SWPRS300	300mm	120kg
SWPRS400	400mm	120kg
SWPRS500	500mm	120kg
SWPRS600	600mm	120kg



PANTRY FRAME

- Adjustable height
- Baskets and runner kit must be purchased separately
- Weight capacity: 120kg
- Chrome finish

Technical Details

CODE	FINISH	DEPTH	HEIGHT
SWPFR	Chrome	505mm	1880mm - 2180mm
SWPFRM	Chrome	505mm	1615mm - 1915mm





LAUNDRY BASKETS

WIRE LAUNDRY BASKETS

- Includes Blum 30kg TANDEM plus runners
- Orion Grey finish
- Made in Italy
- Easy to install
- Life-cycle tested to ensure ongoing and dependable quality
- Suits commercial and residential spaces
- Minimum height: 630mm
- Minimum width: 450mm
- Minimum depth: 515mm

Technical Details

CODE	▶◻◀	INTERNAL WIDTH W/ FRAME	MIN. DEPTH	HEIGHT	CAPACITY
SWL4560	450mm	370mm	515mm	566mm	60L
SWL6090	600mm	520mm	515mm	630mm	90L



LAUNDRY BASKETS

60L LAUNDRY BASKET

- To suit 450mm carcass
- Made in Italy
- Easy to install
- Life-cycle tested to ensure ongoing and dependable quality
- Suits commercial and residential spaces
- To suit Blum MOVENTO 500mm Runners (locking devices not required)
- Movento 40kg or 60kg runner sold separately
- White finish
- Minimum internal cabinet height: 600mm
- Minimum internal cabinet width: 410mm
- Minimum internal cabinet depth: 505mm



Technical Details

CODE	▶◻◀	WIDTH	DEPTH	HEIGHT	CAPACITY
SWL4560W	450mm	414mm	501mm	567mm	60L (1x60L)

Kits

Includes SIGE 60L (1x60L) Laundry Basket and 500mm Blum MOVENTO runners

CODE	CAPACITY	WEIGHT CAPACITY
SWL4560K1	60L (1x60L)	40kg
SWL4560K2	60L (1x60L)	60kg

LAUNDRY BASKETS

60L LAUNDRY BASKET

- To suit 450mm carcass
- Made in Italy
- Easy to install
- Life-cycle tested to ensure ongoing and dependable quality
- Suits commercial and residential spaces
- To suit Blum MOVENTO 500mm runners (locking devices not required)
- Movento 40kg or 60kg runner sold separately
- White finish
- Minimum internal cabinet height: 620mm
- Minimum internal cabinet width: 410mm
- Minimum internal cabinet depth: 505mm



Technical Details

CODE	▶◻◀	WIDTH	DEPTH	HEIGHT	CAPACITY
SWL45260W	450mm	418mm	501mm	610mm	60L (2x30L)

Kits

SIGE 60L (2x30L) Laundry Basket and 500mm Blum MOVENTO runners

CODE	CAPACITY	WEIGHT CAPACITY
SWL45260K1	60L (2x30L)	40kg
SWL45260K2	60L (2x30L)	60kg

LAUNDRY BASKETS

90L LAUNDRY BASKET

- To suit 600mm carcass
- Made in Italy
- Easy to install
- Life-cycle tested to ensure ongoing and dependable quality
- Suits commercial and residential spaces
- To suit Blum MOVENTO 500mm runners (locking devices not required)
- Movento 40kg or 60kg runner sold separately
- White finish
- Minimum internal cabinet height: 600mm
- Minimum internal cabinet width: 560mm
- Minimum internal cabinet depth: 505mm



Technical Details

CODE	▶◻◀	WIDTH	DEPTH	HEIGHT	CAPACITY
SWL6090W	600mm	568mm	501mm	567mm	90L (1x90L)

Kits

Includes SIGE 90L (1x90L) Laundry Basket and 500mm Blum MOVENTO runners

CODE	CAPACITY	WEIGHT CAPACITY
SWL6090K1	90L (1x90L)	40kg
SWL6090K2	90L (1x90L)	60kg

LAUNDRY BASKETS

120L LAUNDRY BASKET

- To suit 800mm carcass
- Made in Italy
- Easy to install
- Life-cycle tested to ensure ongoing and dependable quality
- Suits commercial and residential spaces
- To suit Blum MOVENTO 500mm runners (locking devices not required)
- Movento 60kg runner sold separately
- White finish
- Minimum internal cabinet height: 600mm
- Minimum internal cabinet width: 760mm
- Minimum internal cabinet depth: 505mm

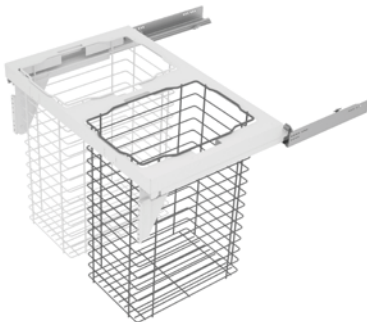

Technical Details

CODE	▶◻◀	WIDTH	DEPTH	HEIGHT	CAPACITY
SWL80120W	800mm	768mm	501mm	567mm	120L (2x60L)

Kits

Includes SIGE 120L (2x60L) Laundry Basket and 500mm 60kg Blum MOVENTO runners

CODE	▶◻◀	CAPACITY	WEIGHT CAPACITY
SWL80120K1	800mm	120L (2x60L)	60kg



UNDER SINK DRAWERS

The SIGE under sink drawers fit perfectly around under sink pipes and are ideal for the organisation of cleaning products.

Suitable for installation in kitchens, bathrooms and laundries, the SIGE under sink drawer integrates the elite runner system created to meet the highest expectations by Blum.

Key Features:

- Made in Italy
- Composed by metal inserts, bucket fittings and dividers
- To suit Blum Tandembox and Legrabox systems

To suit Tandembox 500mm drawers

CODE	FINISH	CARCASE WIDTH	WIDTH	DEPTH	HEIGHT	INSERTS	WEIGHT CAPACITY
SMUSD900T	White	900mm	864mm	505mm	80mm	5 white trays	30 or 65kg*

To suit Legrabox 500mm drawers

CODE	FINISH	CARCASE WIDTH	WIDTH	DEPTH	HEIGHT	INSERTS	WEIGHT CAPACITY
SMUSD900L	White	900mm	864mm	505mm	80mm	5 white trays	40 or 70kg*



UNDER SINK BINS

Wilson & Bradley's exclusively designed SIGE Waste Bin Solutions also offer a range of under sink waste bins.

This Under Sink bin comprises of a metal insert, along with plastic bins and trays. This flexible system is compatible

with all Blum drawer heights and is a great fit for all kitchen applications. Just place in the drawer and it is ready to go!

CODE	CAPACITY	FINISH	CARCASE WIDTH	WIDTH	DEPTH	HEIGHT	LINER BINS
SMUSWB900	45 LITRE	White	900mm	818mm	372mm	280mm	3 x 15L



Contact us for more information on any of our products, or visit our website for instructional videos, promotions and manuals.

Online Store

www.wilbrad.com.au

Phone

1800 633 507

VIC

94 Bell Street
Preston VIC 3072

NSW

Unit 4, 3 Basalt Road
Greystanes NSW 2145

WA

19 Christable Way
Landsdale WA 6065

QLD

105 Corymbia Place
Parkinson QLD 4115

SA

79 Frederick St
Welland SA 5007

TAS

Ph: 1800 633 507



Scan the QR code to view our interactive brochures online.



@wilsonandbradley